



CONNECTILED  
SPÉCIALISTE EN ÉCLAIRAGE LED

CATALOGUE GROK

---

**Grok**  
Light is life.

EDITION 2018

[www.connectiled.com](http://www.connectiled.com)



2 **Grok, light is life.**

Les pièces de Grok modèlent les grands espaces. Elles les transforment et dotent de caractère en fonction du besoin de chaque moment et des professionnels chargés du projet.

Nous dessinons des formes en jouant avec elles. Nous mettons l'accent sur les petits détails, créant ainsi des décors différents et des situations uniques. Grok influe sur l'espace intérieur : il l'agrandit, le réduit, l'ouvre ou le délimite au gré des besoins.

5

Chacune de nos pièces agit comme un élément architectural, comme une sculpture qui projette la lumière en la rendant singulière.

Avec Grok, nous proposons à nos prescripteurs de nombreuses solutions d'éclairage au design.

Avec Grok, nous transformons les grands espaces.













# Index

Pendant  
Suspensión  
Suspension

1.

**ilargi**  
36



**Voiles**  
46



**Candle**  
52



**Saturn**  
66

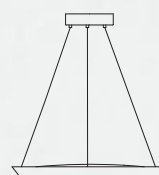

**Circular**  
72

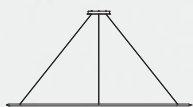

**Tubs**  
86

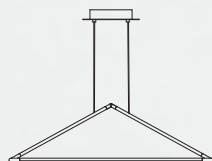

**Invisible**  
94



**Alive**  
104



**Hello**  
109

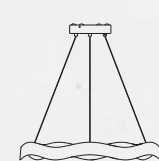

**Circ**  
114

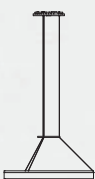

**Net**  
128



**Aura**  
133

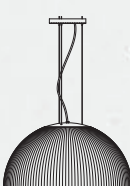

**Umbrella**  
138

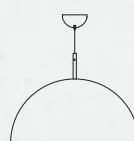

**Angie**  
142



**Spin**  
145

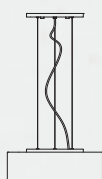

**Tandem**  
149

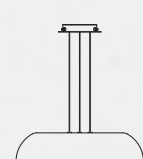

**Bamboo**  
151



**Balloons**  
154

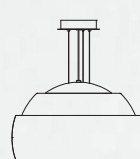

**Ringofire**  
156



---

**Talk**  
160



---

**Clear**  
164



---

**Emy**  
166



---

**Sixties**  
169



---

**Stream**  
172

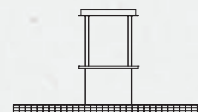

---

**Tulip**  
174



---

**Twins**  
176



---

**Wall  
Pared  
Mural**  
**2.**

---

**Invisible**  
180



---

**Big Bang**  
184



---

**Prime**  
188



---

**Rizz**  
194



---

**Bend**  
198



---

**Surf**  
202



---

**Flavia**  
206



---

**Hall**  
210

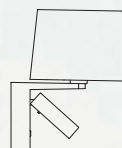

---

**Talk**  
214



---

**Emy**  
217

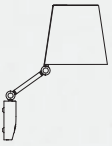

---

**Skata**  
220

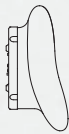

---

**Igloo**  
222



---

**Suite**  
224



---

**Wave**  
226



---

**Flat**  
228

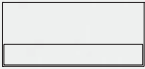

---

**Table  
Sobremesa  
Table**  
**3.**

---

**Cocktail**  
232



---

**ilargi**  
240

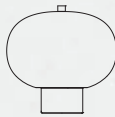

---

**Invisible**  
244



---

**Premium**  
248

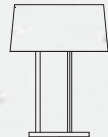

---

**Hall**  
252

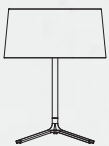

---

**Flavia**  
258



---

**Talk**  
262



---

**Emy**  
264



Floor  
Pie  
Pied

4.

Invisible  
268

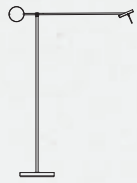

Premium  
272



Hall  
276



Circ  
282

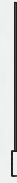

Flavia  
286



Bosquet  
290



Bamboo  
293



Emy  
296



Medusa  
299



Ceiling  
Techo  
Plafond

5.

Circ  
304



Spin  
308



Six  
310



Igloo  
313



Tandem  
316



Single  
318

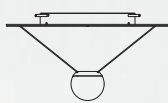

# Collections index

---

**Alive**  
104



**Angie**  
142



**Aura**  
133



**Balloons**  
154

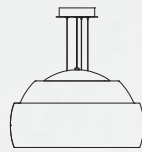

---

**Bamboo**  
151



293



**Bend**  
198



**Big Bang**  
184



**Bosquet**  
290



28

---

**Candle**  
52



58

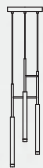

62

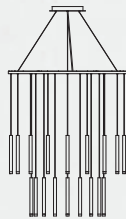

---

**Circ**  
114

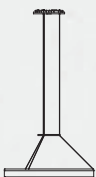

118

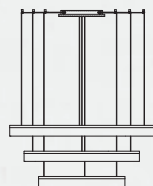

122

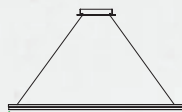

124

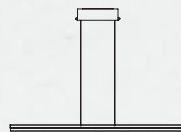

282



304



---

**Circular**

72

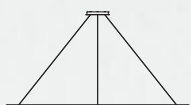

80

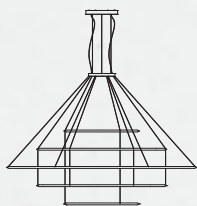

---

**Clear**

164



---

**Cocktail**

232



---

**Emy**

166



217



264



296



---

**Flat**

228

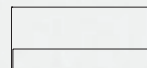

---

**Flavia**

206



258



286



---

**Hall**

210

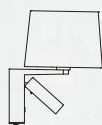

252



276



---

**Hello**

109

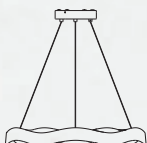

---

**Igloo**

222



313



**ilargi**

36



38



240

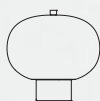

**Invisible**

94



98

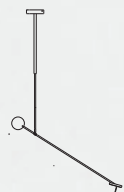

100

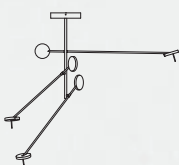

180



244

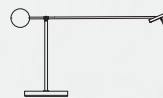

268

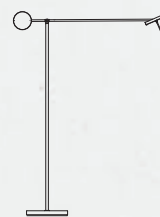

**Medusa**

299



**Net**

128



130

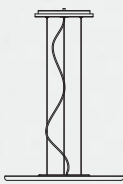

131

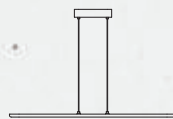

**Premium**

248



272



**Prime**

188

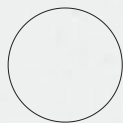

**Ringofire**

156



**Rizz**

194



**Saturn**

66

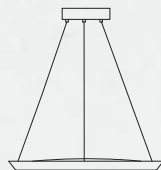

**Single**

318

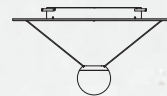

**Six**

310



**Sixties**

169



**Skata**

220



**Spin**

145

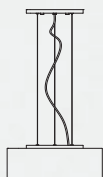

308



**Stream**

172

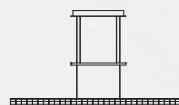

**Suite**

224



**Surf**

202



**Talk**

160



214



262



**Tandem**

149

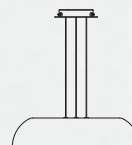

316



**Tubs**

86

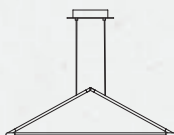

**Tulip**

174



**Twins**

176



**Umbrella**

138

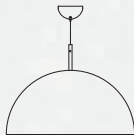

**Voiles**

46



**Wave**

226

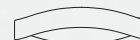





# Grok

Pendant  
Suspensión  
Suspension

ilargi	36
Voiles	46
Candle	52
Saturn	66
Circular	72
Tubs	86
Invisible	94
Alive	104
Hello	109
Circ	114
Net	128
Aura	133
Umbrella	138
Angie	142
Spin	145
Tandem	149
Bamboo	151
Balloons	154
Ringofire	156
Talk	160
Clear	164
Emy	166
Sixties	169
Stream	172
Tulip	174
Twins	176









# ilargi

**Naturalness.** This light, which evokes the “moon” in Basque, has a subtle and minimalist design, comprising a wooden rod inserted into a handblown glass ball. Reminiscent of an artistic sculpture, the light hangs in the air, and the combination of two sizes of glass creates a double suspension.

**Naturalidad.** Esta luminaria, que en euskera evoca a la luna, presenta una sutil y mínima intervención en la que una vara de madera se introduce en una bola de vidrio soplado a mano y queda suspendida en el aire como un elemento escultórico. La combinación de dos tamaños de vidrio permite una doble suspensión.

**Tout en naturel.** Ce luminaire, dont le nom basque évoque la lune, arbore une tige en bois subtilement introduite dans une boule en verre soufflé à la main qui se retrouve suspendue dans l'air comme un élément sculptural. L'association de deux dimensions de verre permet de créer une double suspension.

## Finishing | Acabados | Finitions



44

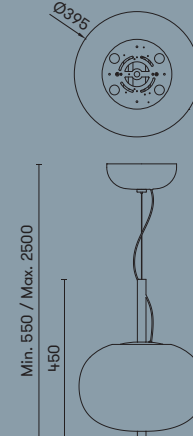
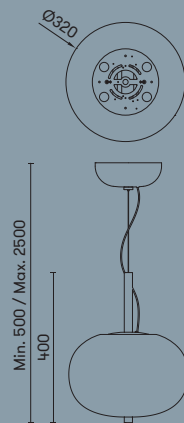
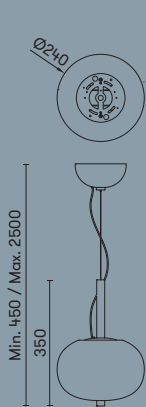

- 00-6010-92-F9 ■ (1-10V) 120
- 00-6010-93-F9 ■ (1-10V) 277V
- 00-6452-92-F9 ■ (Phase Cut)
- 00-6452-93-F9 ■ (Phase Cut)
- 00-6454-92-F9 ■ (Dali)
- 00-6454-93-F9 ■ (Dali)

LED 8.5W  
800 lm 2700K

- 00-6011-92-F9 ■ (1-10V) 120
- 00-6011-93-F9 ■ (1-10V) 277V
- 00-6455-92-F9 ■ (Phase Cut)
- 00-6455-93-F9 ■ (Phase Cut)
- 00-6457-92-F9 ■ (Dali)
- 00-6457-93-F9 ■ (Dali)

LED 14.8W  
1315 lm 2700K

- 00-6012-92-F9 ■ (1-10V) 100
- 00-6012-93-F9 ■ (1-10V) 240V
- 00-6458-92-F9 ■ (Phase Cut)
- 00-6458-93-F9 ■ (Phase Cut)
- 00-6460-92-F9 ■ (Dali)
- 00-6460-93-F9 ■ (Dali)

LED 21.4W  
1880 lm 2700K



Finishing | Acabados | Finitions

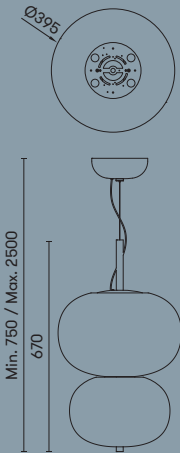
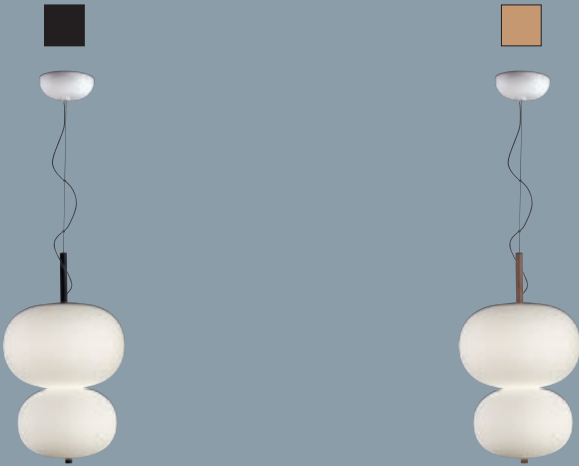

- 00-6013-92-F9 ■ (1-10V) 100
- 00-6013-93-F9 ■ (1-10V) 240V
- 00-6461-92-F9 ■ (Phase Cut)
- 00-6461-93-F9 ■ (Phase Cut)
- 00-6463-92-F9 ■ (Dali)
- 00-6463-93-F9 ■ (Dali)

LED 36.1W  
3195 lm 2700K



Finishing | Acabados | Finitions

- 92 Fresno dark | Fresno oscuro | Frêne foncé
- 93 Fresno light | Fresno claro | Frêne clair

Materials | Materiales | Matériaux

- WOOD Wood | Madera | Bois
- ST Steel | Acero | Acier
- GLASS  
OPAL3  
DIF Diffuser material triplex opal glass | Material difusor cristal opal triplex | Matériau diffusant verre opal triplex

## Collection

Illuminates your spaces alongside the other pieces that comprise this collection.

## Colección

Ilumina tus espacios con el resto de piezas que componen esta colección.

## Collection

Éclairer vos espaces avec le reste des pièces de cette collection.



Table  
Sobremesa  
Table p. 240

Céline Wright

---

# Voiles



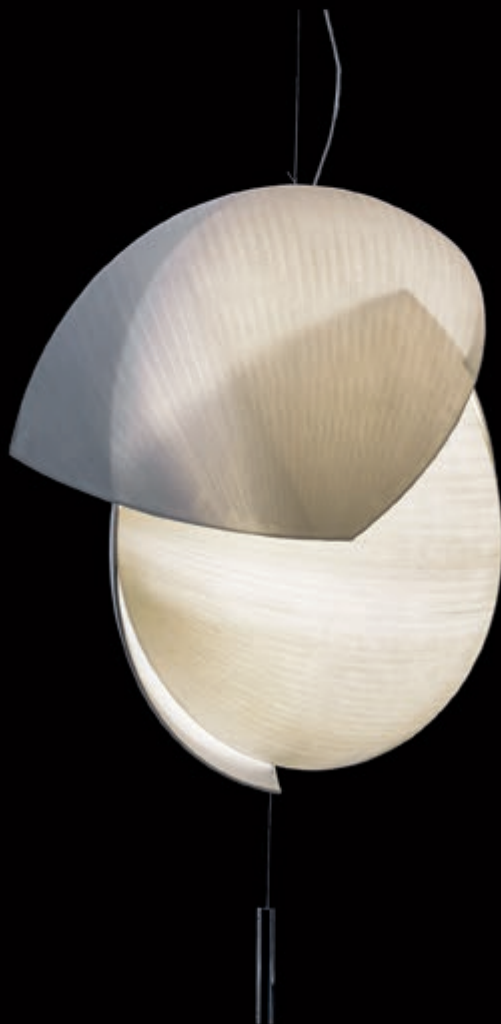



# Voiles



**Craftsmanship.** Clarity, poetry and harmony set the tone of this luminaire, which comes in two sizes and is ideal for large spaces. Hand crafted in Paris, the light fitting features a hanging cord and an asymmetrical, four-sided design produced in Washi Japanese paper, which captures the light to create a distinctive ambience wherever it is installed.

**Artesanía.** La claridad, la poesía y el equilibrio marcan el espíritu de esta luminaria, ideal para grandes espacios y disponible en dos tamaños. De forma asimétrica y hecha a mano en París, sus cuatro caras diferentes, el cordón colgante y el papel japonés atrapan la luz dotando de mucha personalidad al lugar donde se ubica.

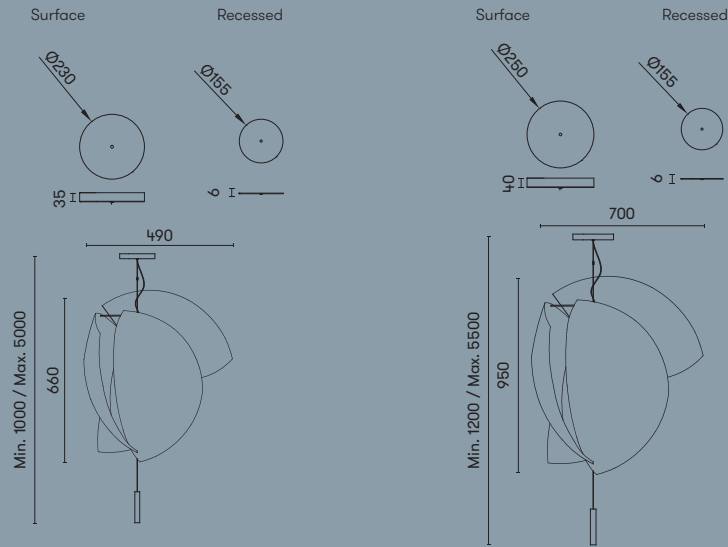
**Artisanat.** Clarté, poésie et équilibre marquent l'esprit de ce luminaire, idéal pour les grands espaces et disponible en deux formats. De forme asymétrique et fait à la main à Paris, ses quatre faces différentes, le cordon suspendu et le papier japonais attrapent la lumière pour mieux doter de personnalité l'espace qui l'accueille.







Surface  
 00-6306-21-14 (Phase Cut)    
 00-6307-21-14 (1-10V)   
 00-6308-21-14 (Dali)  

Recessed  
 00-6317-21-14 (Phase Cut)    
 00-6318-21-14 (1-10V)   
 00-6319-21-14 (Dali)  

LED 32.5W  
 4440 lm 3000K

Surface  
 00-6303-21-14 (Phase Cut)    
 00-6304-21-14 (1-10V)   
 00-6305-21-14 (Dali)  

Recessed  
 00-6314-21-14 (Phase Cut)    
 00-6315-21-14 (1-10V)   
 00-6316-21-14 (Dali)  

LED 47.5W  
 6805 lm 3000K



## Finishing | Acabados | Finitions

 21 Chrome | Cromo | Chrome

## Materials | Materiales | Matériaux

 ST Steel | Acero | Acier

 PAPER SHADE Shade material japanese paper | Material pantalla papel japonés | Matériau de l'abat-jour en papier japonais



Benedito Design

---

# Candle









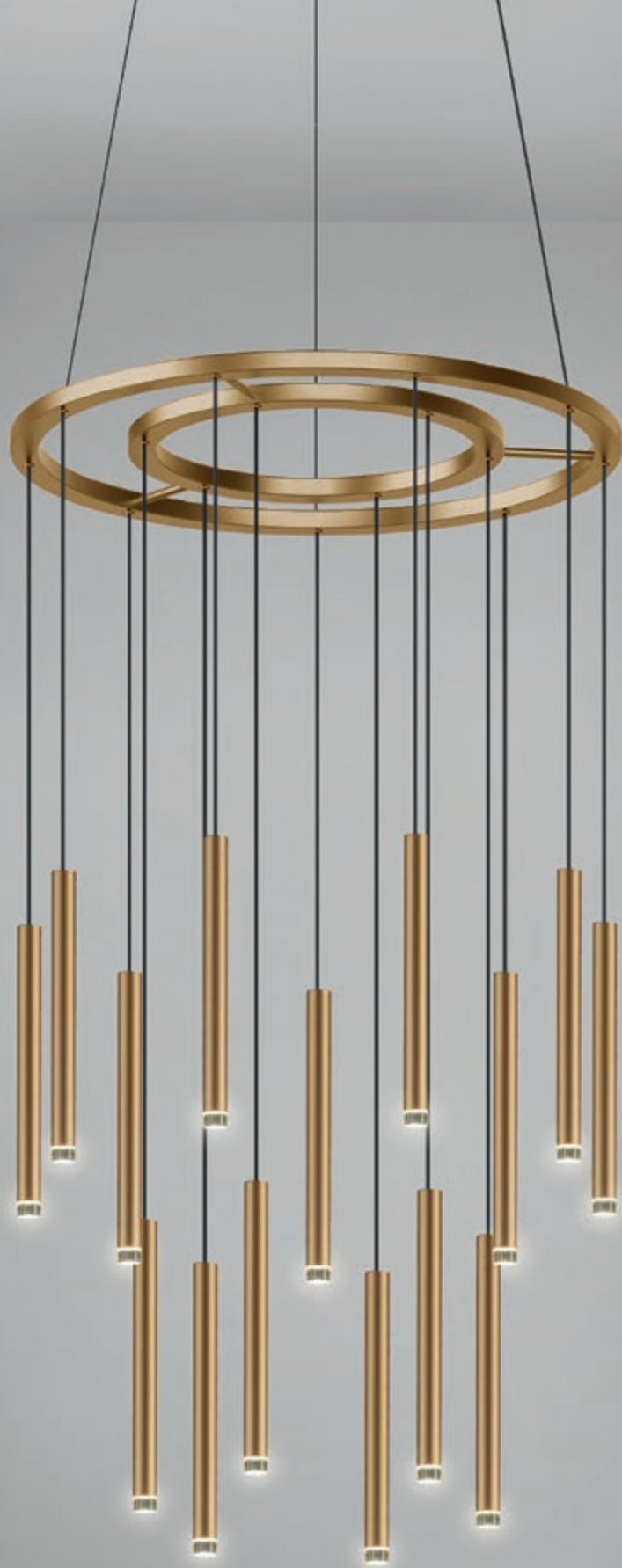



# Candle

**Poetry.** The adaptation of a classic candle holder with a LED light source has produced this delicate luminaire, a real gem. The poetic and refined light creates and accentuates different areas. It also comes in an individual and triple version, and as a chandelier.

**Poética.** La reinterpretación de un candelabro clásico con fuente de luz led ha dado lugar a esta delicada luminaria que le confiere el valor de una joya. La proyección de su luz poética y refinada crea y acentúa espacios. También disponible en las versiones individual, triple y como un chandelier.

**Poétique.** La réinterprétation d'un candélabre classique à source lumineuse LED a donné naissance à ce délicat luminaire qui prend des allures de bijou. La projection de sa lumière poétique et raffinée crée et accentue les espaces. Également disponible en versions individuelle, triple et chandelier.

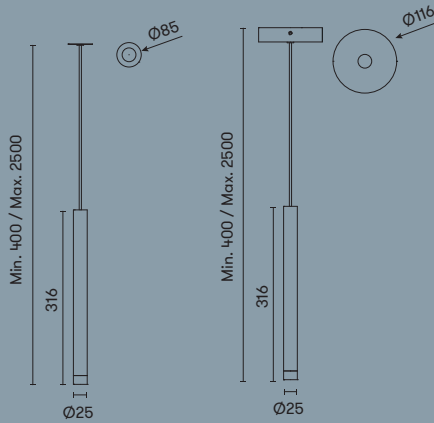

00-6018-27-27\*\*

00-6017-27-27\*\*

LED 3W A++ A  
358 lm 2700K

LED 3W A++ A  
358 lm 2700K

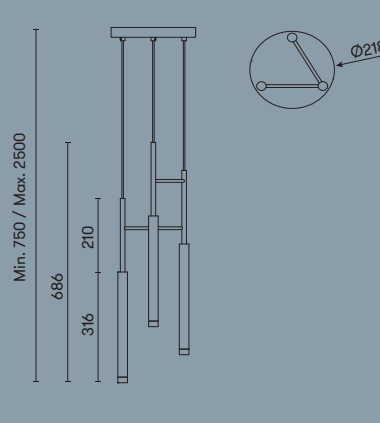

00-6021-27-27 (Mains dimming)\*

LED 3x3W A++ A  
1075 lm 2700K

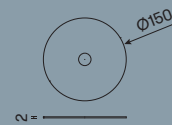

\*\* 71-6022-27-27

Optional accessory |  
Accesorio opcional |  
Accessoire en option

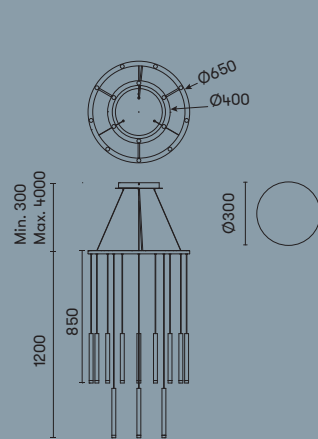

00-6019-27-27 (Dimmable 1-10V)  
00-6020-27-27 (Dimmable DALI)

LED 15x3W A++ A  
5452 lm 2700K

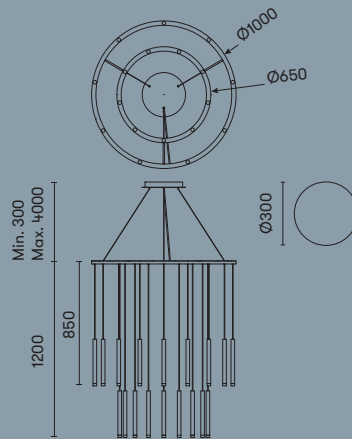

00-6066-27-27 (Dimmable 1-10V)  
00-6067-27-27 (Dimmable DALI)

LED 18x3W A++ A  
6700 lm 2700K



## Finishing | Acabados | Finitions

27 Matt satin finished brass | Latón satinado mate | Laiton satiné mat

## Materials | Materiales | Matériaux

ST Steel | Acero | Acier

PMMA Diffuser material PMMA | Material difusor  
DIF PMMA | Matériau diffusant PMMA

\* Mains dimmer compatibility at [www.leds-c4.com](http://www.leds-c4.com) (Products & Downloads)

\* Compatibilidad con reguladores corte de fase en [www.leds-c4.com](http://www.leds-c4.com) (Productos & Descargas)

\* Compatible avec des variateurs en coupure de phase que vous pouvez consulter [www.leds-c4.com](http://www.leds-c4.com) (Produits & Téléchargements)

## New ceiling rose system for a variety of compositions | Nuevo sistema de florón para crear composiciones distintas | Nouveau système de montage permettant de créer différentes compositions

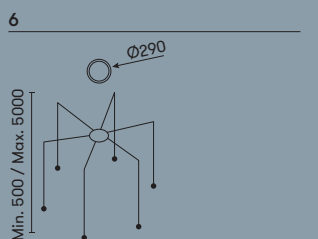

00-6662-14-14 (1-10V)  
00-6663-14-14 (Dali)

LED 18,8W A++ A  
2165 lm 2700K

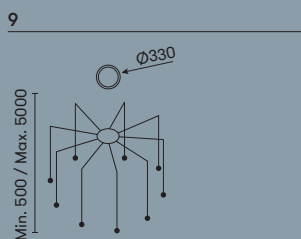

00-6664-14-14 (1-10V)  
00-6665-14-14 (Dali)

LED 28,1W A++ A  
3250 lm 2700K

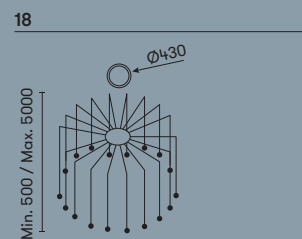

00-6666-14-14 (1-10V)  
00-6667-14-14 (Dali)

LED 62,8W A++ A  
6700 lm 2700K

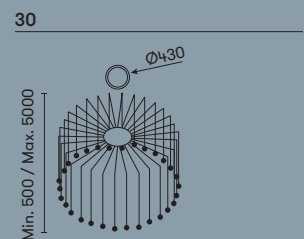

00-6668-14-14 (1-10V)  
00-6669-14-14 (Dali)

LED 98,8W A++ A  
10900 lm 2700K











# Saturn

**Serenity.** This next-generation lamp's hallmark is its purity, simplicity and the timelessness of its lines. Each of its characteristics has been included to add a specific value.

**Serenidad.** La seña de identidad de esta lámpara de última generación se encuentra en la pureza, sencillez y atemporalidad de sus líneas. Cada uno de sus detalles han sido incorporados para ofrecer un valor determinado.

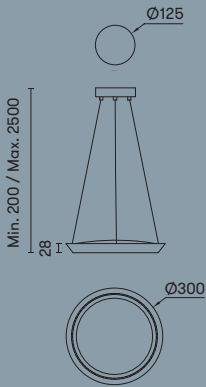
**Sérénité.** La caractéristique de cette lampe dernière génération se trouve dans la pureté, la simplicité et l'intemporalité de ses lignes. Chacun des détails a été intégré pour apporter une certaine valeur.



00-6015-27-M1  (Mains dimming)\*

LED 13W A++ A  
1300 lm 2700K

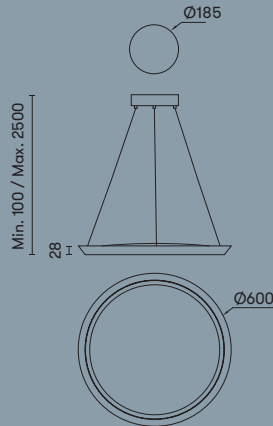

00-6014-27-M1  (Mains dimming)\*

LED 40W A++ A  
4000 lm 2700K



## Finishing | Acabados | Finitions

 27 Matt satin finished brass | Latón satinado mate | Laiton satiné mat

## Materials | Materiales | Matériaux

 Diffuser material polystyrene | Material difusor Poliéstireno | Matériau diffusant Polystyrène

 Steel | Acero | Acier

\* Mains dimmer compatibility at [www.leds.c4.com](http://www.leds.c4.com) (Products & Downloads)

\* Compatibilidad con reguladores corte de fase en [www.leds-c4.com](http://www.leds-c4.com) (Productos & Descargas)

\* Compatible avec des variateurs en coupure de phase que vous pouvez consulter [www.leds-c4.com](http://www.leds-c4.com) (Produits & Téléchargements)



Benedito Design

---

# Circular















# Circular

**Customisation.** This luminaire combines technology and decoration to provide complete flexibility through a choice of sizes, finishes, installation and adaptability. The circular aluminium-extruded frames can be installed in an individual hanging light or combined in a chandelier.

**Personalización.** Esta luminaria, que combina tecnología y decoración, ofrece una flexibilidad total al permitir escoger dimensión, acabados, instalación y regulación. Sus perfiles circulares de aluminio extrusionado pueden instalarse como un colgante individual o combinarlos entre ellos como un chandelier.

**Personnalisation.** Alliant technologie et décoration, ce luminaire offre une flexibilité totale en permettant de choisir la dimension, les finitions, l'installation et le réglage. Ses profils circulaires en aluminium extrudé peuvent s'installer sous forme de suspension individuelle ou associés entre eux comme un chandelier.

## Light direction | Dirección de la luz | Direction de la lumière

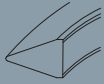

**D** Inward  
Interior  
Intérieur

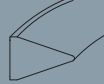

**F** Outward  
Exterior  
Extérieur

## Ceiling rose | Tipo florón | Type de monture



**4** Surface  
Superficie  
Surface



**5** Recessed  
Empotrable  
Encastrés

## Model | Modelo | Modèle



**A** Ø600 mm 34W  
2880 lm



**B** Ø1200 mm 69W  
5760 lm



**C** Ø2000 mm 120W  
10080 lm

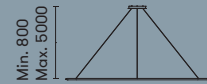

**D** Ø3000 mm 178W  
14880 lm

84

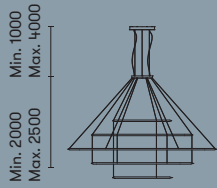

**E** Ø1200 mm 558W  
Ø2000 mm 46560 lm  
Ø3000 mm  
Ø2000 mm  
Ø1200 mm

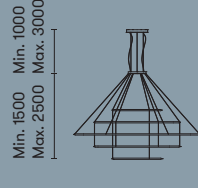

**F** Ø600 mm 328W  
Ø1200 mm 27360 lm  
Ø2000 mm  
Ø1200 mm  
Ø600 mm

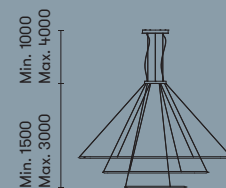

**G** Ø3000 mm 368W  
Ø2000 mm 30720 lm  
Ø1200 mm

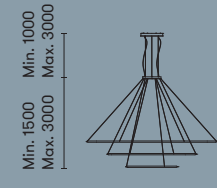

**H** Ø2000 mm 224W  
Ø1200 mm 18720 lm  
Ø600 mm

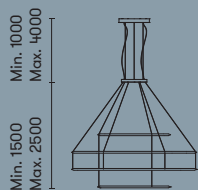

**I** Ø1200 mm 380W  
Ø2000 mm 31680 lm  
Ø2000 mm  
Ø1200 mm

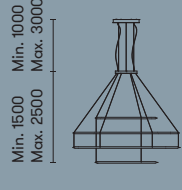

**J** Ø600 mm 207W  
Ø1200 mm 17280 lm  
Ø1200 mm  
Ø600 mm

## Kelvin

**A** 2400      **V** 2700      **W** 3000 (Standard)      **X** 4000

## Power supply | Alimentación | Alimentation

**OU** On / Off — 100-240V      **DU** Dali — 100-240V

**RU** 0 - 10V — 100-240V

## 71-5961-00-00

Optional accessory Casambi, models A B C - Accesorio opcional Casambi modelos A B C - Accessoire en option Casambi, modèles A B et C

## Finishing | Acabados | Finitions



**14** White - Blanco - Blanc





**05** Black - Negro - Noir

Customise your product | Personaliza tu producto | Personnalisez votre produit

Reference example | Ejemplo de referencia | Exemple de référence

<b>C</b>	<b>F</b>	<b>4</b>	<b>G</b>	<b>-</b>	<b>00</b>	<b>X</b>	<b>9</b>	<b>AZ</b>	<b>DU</b>	<b>05</b>
			Ø3000 Ø2000 Ø1200			4000			DALI	Black Negro Noir

Product range Familia Famille	Light direction Dirección luz Direction de la lumière	Ceiling rose Florón Monture	Model Modelo Modèle	Guide Guión Trait d'union	Power Potencia Puissance	Kelvin Kelvin Kelvin	CRI CRI CRI	Angle Ángulo Angle	Power supply Alimentación Alimentation	Finish Acabados Finition								
<b>C</b>	Inward Interior Intérieur	 <b>4</b>	Ø600 <b>A</b>	—	<b>00</b>	2400 <b>A</b>	CRI >90 <b>9</b>	<b>AZ</b>	ON / OFF <b>OU</b>	White Blanco Blanc <b>14</b>								
			Ø1200 <b>B</b>			2700 <b>V</b>												
			Outward Exterior Extérieur			 <b>5*</b>					Ø2000 <b>C</b>	3000 <b>W</b> (Standard)	DALI <b>DU</b>	Black Negro Noir <b>05</b>				
											Ø3000 <b>D</b>	0 - 10V <b>RU</b>						
											Ø1200 <b>E</b>				4000 <b>X</b>			
											Ø2000 <b>E</b>							
	Ø3000 <b>E</b>																	
	Ø1200 <b>E</b>																	
	Ø600 <b>F</b>	Ø1200 <b>F</b>	Ø2000 <b>F</b>		Ø1200 <b>F</b>	Ø600 <b>F</b>												
							Ø3000 <b>G</b>	Ø2000 <b>G</b>	Ø1200 <b>G</b>									
										Ø2000 <b>H</b>	Ø1200 <b>H</b>	Ø600 <b>H</b>						
													Ø1200 <b>I</b>	Ø2000 <b>I</b>	Ø2000 <b>I</b>	Ø1200 <b>I</b>		
Ø600 <b>J</b>				Ø1200 <b>J</b>													Ø1200 <b>J</b>	Ø600 <b>J</b>

\* Can only be combined with the models A B C D - Combinable solo con los modelos A B C D - Combinable uniquement avec les modèles A, B, C et D









# Tubs

**Balance.** With its unique design, the geometry of its pyramid-shaped lines trap the light inside, delicately highlighting and creating order wherever it is used. Its soft but powerful light makes it the perfect versatile accompaniment for large spaces.

**Equilibrio.** De diseño único, su juego geométrico de líneas piramidales atrapa la luz en su interior marcando y ordenando con delicadeza los espacios donde se instala. Su tenue pero potente luz la presenta como una pieza versátil ideal para grandes espacios.

**Équilibre.** Avec un design unique, son jeu géométrique de lignes pyramidales capte la lumière à l'intérieur pour marquer et ajuster délicatement les espaces où elle est installée. Sa ténue, mais puissante lumière la présente comme une pièce polyvalente idéale pour les grands espaces.

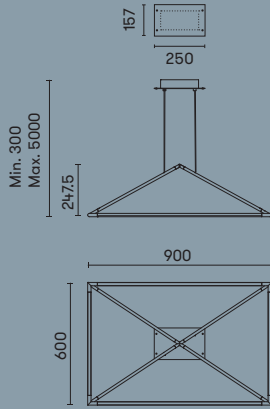

00-5999-05-M1 ■  
00-6001-05-M1 ■ (Dimmable DALI)

LED 36W A++ A  
3900 lm 3000K

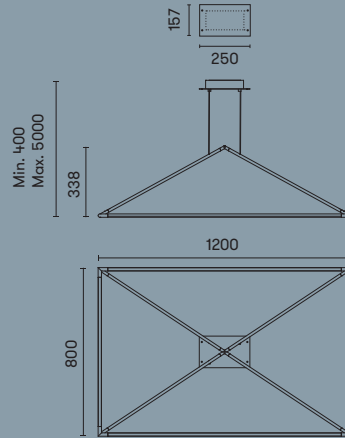

00-6000-05-M1 ■  
00-6002-05-M1 ■ (Dimmable DALI)

LED 48W A++ A  
5200 lm 3000K

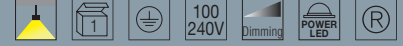

## Finishing | Acabados | Finitions

05 Black | Negro | Noir

## Materials | Materiales | Matériaux

AL Aluminium | Aluminio | Aluminium

PMMA Diffuser material PMMA | Material difusor  
DIF PMMA | Matériau diffusant PMMA



Francesc Vilaró

---

# Invisible







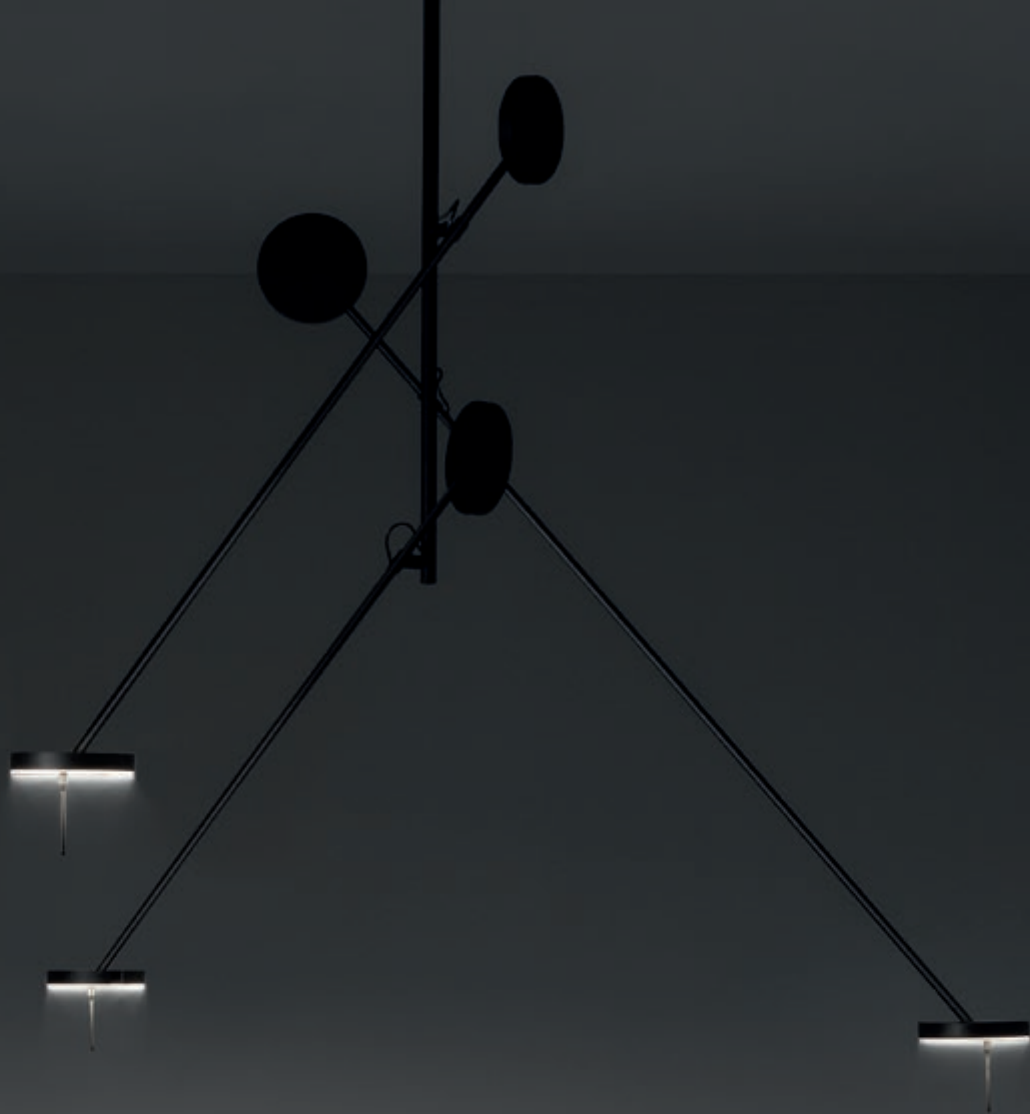

# Invisible

**Authenticity.** The simplicity of this collection makes it unique and gives it authenticity and an individual identity. The different positions for its arms and heads generate multiple compositions that convey a sense of almost complete weightlessness reminiscent of a mobile.

**Autenticidad.** La simplicidad de esta colección la hace única, auténtica y con identidad propia. Las diferentes posiciones de sus brazos y cabezales generan múltiples composiciones que transmiten una percepción casi de ingravidez que nos recuerda a un móvil.

**Authenticité.** La simplicité de cette collection la rend unique, authentique et avec une identité propre. Les différentes options de positions de ses bras et de ses têtes permettent de créer de multiples compositions qui donnent une perception d'apesanteur rappelant un mobile.

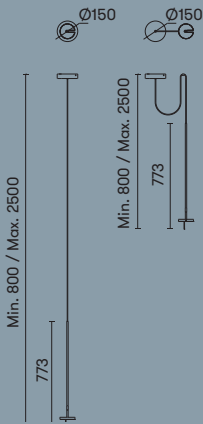

00-5693-05-05 ■ (Mains dimming)\*

LED 9W A++ A  
765 lm 3000K

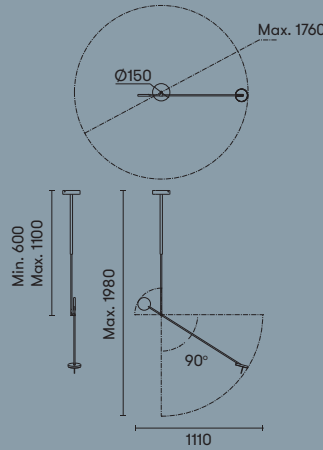

00-5694-05-05 ■ (Mains dimming)\*

LED 9W A++ A  
765 lm 3000K

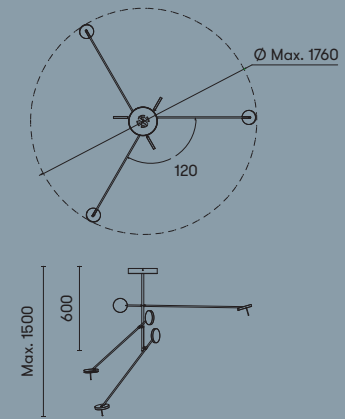

00-5695-05-05 ■ (Standard)   
00-5696-05-05 ■ (Mains dimming)\*

LED 27W A++ A  
2295 lm 3000K

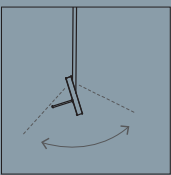

## Finishing | Acabados | Finitions

05 Black | Negro | Noir

## Materials | Materiales | Matériaux

ST Steel | Acero | Acier

PMMA Diffuser material PMMA | Material difusor PMMA | Matériau diffusant PMMA

\* Mains dimmer compatibility at [www.leds-c4.com](http://www.leds-c4.com) (Products & Downloads)

\* Compatibilidad con reguladores corte de fase en [www.leds-c4.com](http://www.leds-c4.com) (Productos & Descargas)

\* Compatible avec des variateurs en coupure de phase que vous pouvez consulter [www.leds-c4.com](http://www.leds-c4.com) (Produits & Téléchargements)

## Collection

Illuminates your spaces alongside the other pieces that comprise this collection.

## Colección

Ilumina tus espacios con el resto de piezas que componen esta colección.

## Collection

Éclairer vos espaces avec le reste des pièces de cette collection.



Wall  
Pared  
Mural p. 180



Table  
Sobremesa  
Table p. 244



Floor  
Pie  
Pied p. 268



Francesc Vilaró

---

**Alive**



# Alive

**Clarity.** Its timeless design is based on the bare minimum required for illumination; the light source. Its multiple configurations allow various lighting needs to be personalised and resolved. The high-quality frosted glass lampshade offers a silky, diffuse and warm light.



**Claridad.** Su diseño atemporal se basa en el elemento mínimo, la fuente de luz. Sus múltiples configuraciones ofrecen diferentes soluciones. El cristal matizado de alta calidad de la pantalla, soplado a mano, ofrece una luz sedosa, difusa y cálida. Disponible en dos acabados, cromado y negro, con un cable realmente fino y tornillos invisibles.

**Clarté.** Son design intemporel est basé sur l'élément minimal nécessaire pour éclairer : la source de lumière. Ses multiples configurations permettent de personnaliser et de fournir des solutions aux différents besoins d'éclairage. L'écran en verre trempé de grande qualité offre une lumière soyeuse, chaude et diffuse.



## Finishing | Acabados | Finitions



## Finishing | Acabados | Finitions



-  05 Black | Negro | Noir
-  21 Chrome | Cromo | Chrome

## Materials | Materiales | Matériaux

-  Aluminium | Aluminio | Aluminium
-  Diffuser material PMMA | Material difusor PMMA | Matériau diffusant PMMA
-  Diffuser material glass | Material difusor Cristal | Matériau diffusant Verre

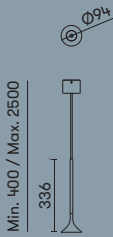

108

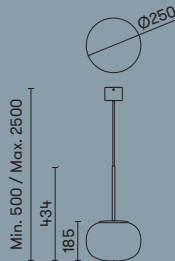

00-6670-05-05   
00-6670-21-21 

LED 6.9W A++ A  
575 lm 2700K



00-6671-05-F1   
00-6671-21-F1 

LED 6.9W A++ A  
575 lm 2700K

## New ceiling rose system for a variety of compositions | Nuevo sistema de florón para crear composiciones distintas | Nouveau système de montage permettant de créer différentes compositions

Grok introduces a ceiling rose that allows 4 different assembly types with multiple hanging lights: 6, 9, 18 and 30. The system is available in a standard white finish, dimming 1-10V and Dali.

Grok introduce un florón en el techo que permite 4 formatos diferentes de montaje con múltiples colgantes: 6, 9, 18 y 30. Este sistema está disponible en acabado estándar blanco y regulación 1-10V y Dali.

Grok introduit une monture au plafond qui permet 4 formats différents de montage à suspensions multiples : 6, 9, 18 et 30. Ce système est disponible en finition blanche standard, ainsi qu'en atténuation 1-10V et Dali.

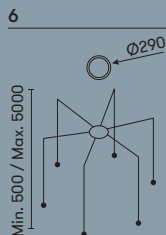

00-7064-05-05  (1-10V)  
00-7064-21-21  (1-10V)  
00-7074-05-05  (Dali)  
00-7074-21-21  (Dali)

LED 41.1W A++ A  
3450 lm 2700K

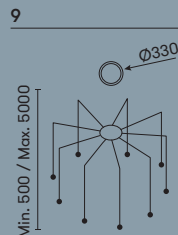

00-7065-05-05  (1-10V)  
00-7065-21-21  (1-10V)  
00-7075-05-05  (Dali)  
00-7075-21-21  (Dali)

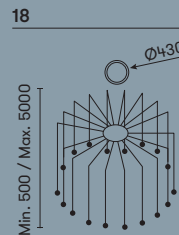

LED 61.7W A++ A  
5175 lm 2700K

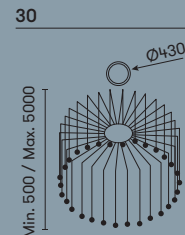

00-7066-05-05  (1-10V)  
00-7066-21-21  (1-10V)  
00-7076-05-05  (Dali)  
00-7076-21-21  (Dali)

LED 123.4W A++ A  
10350 lm 2700K



00-7067-05-05  (1-10V)  
00-7067-21-21  (1-10V)  
00-7077-05-05  (Dali)  
00-7077-21-21  (Dali)

LED 210W A++ A  
17250 lm 2700K



Josep Patsí

---

# Hello







# Hello

**Harmony.** The sea and waves are the main source of inspiration. Its shapes and contrasts generate an intimate atmosphere through warm and comfortable light. Lending its personality to wherever it is installed and its visual comfort harmonises spaces with different styles.

**Armonía.** El mar y sus olas son su principal inspiración. Sus formas y contrastes generan un clima íntimo mediante una luz cálida y confortable. Otorga personalidad donde se ubica y su confort visual armoniza espacios de diferentes estilos.

**Harmonie.** La mer et ses vagues sont sa principale source d'inspiration. Ses formes et ses contrastes créent une atmosphère intime avec une lumière chaude et confortable. Elle apporte de la personnalité à l'endroit où elle se trouve et son confort visuel harmonise les espaces de styles différents.

## Finishing | Acabados | Finitions

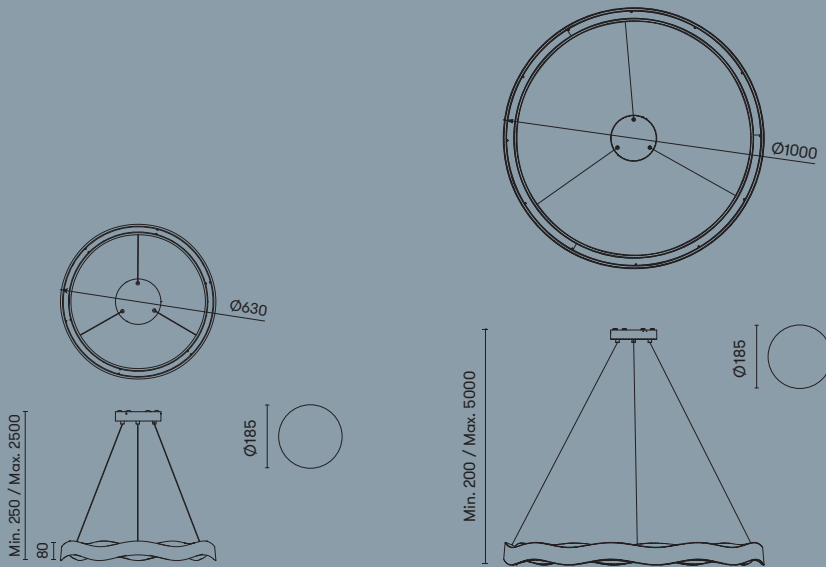
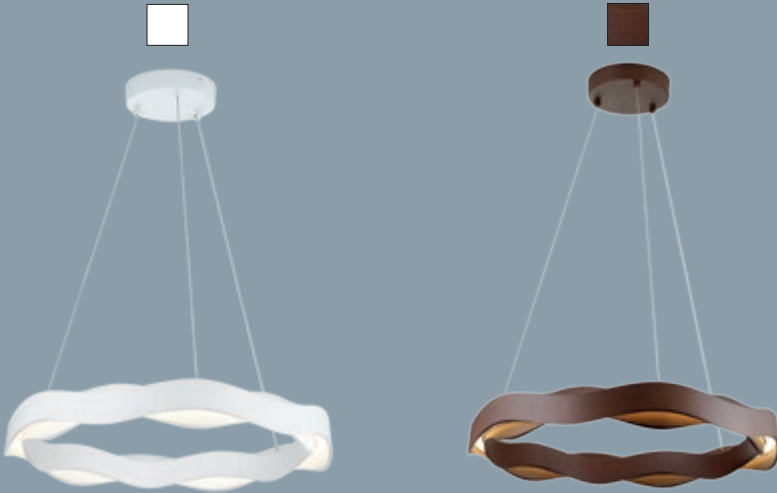

## Finishing | Acabados | Finitions

- BW** Matt white | Blanco mate | Blanc mate
- CT** Wood brown | Marrón madera | Bois marron

## Materials | Materiales | Matériaux

- PMMA** Diffuser material PMMA | Material difusor PMMA | Matériau diffusant PMMA
- DIF** PMMA | Matériau diffusant PMMA
- PUR** Polyurethane | Poliuretano | Polyuréthane

\* Mains dimmer compatibility at [www.leds.c4.com](http://www.leds.c4.com) (Products & Downloads)

\* Compatibilidad con reguladores corte de fase en [www.leds.c4.com](http://www.leds.c4.com) (Productos & Descargas)

\* Compatible avec des variateurs en coupure de phase que vous pouvez consulter [www.leds.c4.com](http://www.leds.c4.com) (Produits & Téléchargements)

- 00-5275-BW-M1  (Mains dimming)\* 2700K
- 00-5498-BW-M1  (Mains dimming)\* 3000K
- 00-5275-CT-M1  (Mains dimming)\* 2700K

LED 24,3W A++ A  
2300 lm

- 00-5958-BW-M1  (Mains dimming)\* 2700K
- 00-5958-CT-M1  (Mains dimming)\* 2700K

LED 33,5W A++ A  
3450 lm













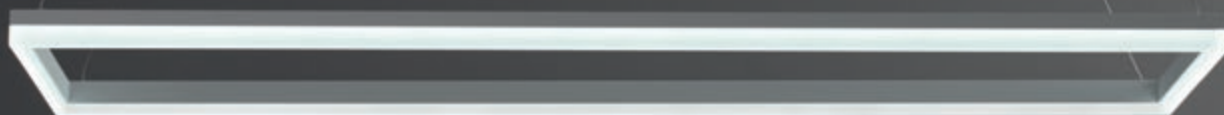





# Circ

**Lightness.** The design of this pendant lamp offers diffuse lighting and provides great versatility in any space. It can be installed in a circular or linear format in a combination of different shapes and sizes.

**Ligereza.** El diseño de esta luminaria de suspensión ofrece una iluminación muy difusa y permite una gran versatilidad en los espacios. Puede instalarse de manera circular o lineal y realizar combinaciones de formas y tamaños diferentes.

**Légèreté.** Le design de ce luminaire en suspension offre un éclairage très diffus et permet une grande polyvalence dans l'espace. On peut l'installer de manière circulaire ou linéaire et réaliser des combinaisons de formes et de dimensions différentes.

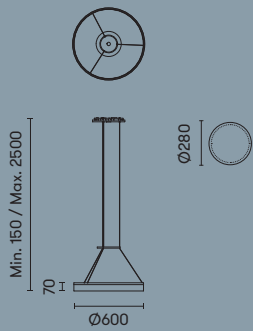

00-0001-BW-M3  (Standard)  
00-0641-BW-M3  (Dimmable 1-10V)

LED 22W A++ A  
2112 lm 3000K

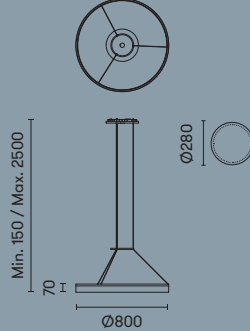

00-0002-BW-M3  (Standard)  
00-0642-BW-M3  (Dimmable 1-10V)

LED 31W A++ A  
2976 lm 3000K

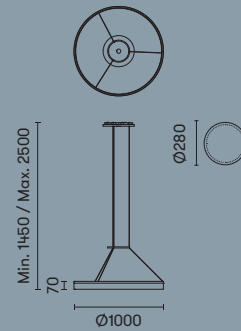

00-3642-BW-M3  (Standard)  
00-3646-BW-M3  (Dimmable 1-10V)

LED 36W A++ A  
3456 lm 3000K

126

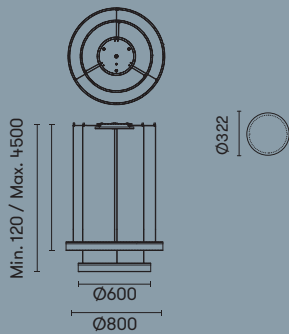

00-3647-BW-M3  (Standard)

LED 53W A++ A  
5088 lm 3000K

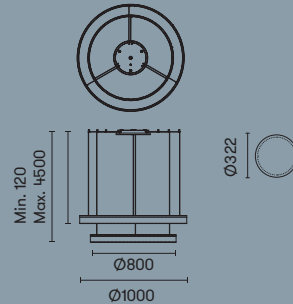

00-3648-BW-M3  (Standard)

LED 67W A++ A  
6432 lm 3000K

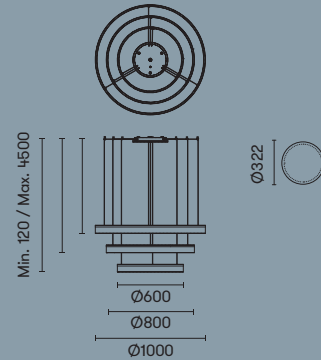

00-3649-BW-M3  (Standard)

LED 89W A++ A  
8544 lm 3000K



## Finishing | Acabados | Finitions

**BW** Matt white | Blanco mate | Blanc mate

## Materials | Materiales | Matériaux

**AL** Aluminium | Aluminio | Aluminium

**PMMA** Diffuser material PMMA | Material difusor PMMA | Matériau diffusant PMMA



71-2241-00-00

Controller with remote control for **Standard Version** | Controlador con mando a distancia para **Versiones Standard** | Contrôleur avec télécommande pour **Versions Standard**



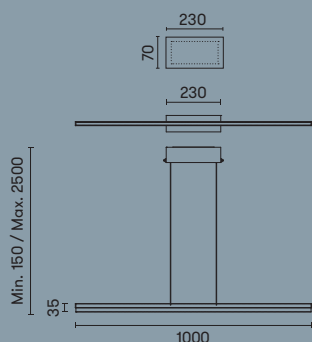

00-2934-BW-M3  (Standard)  
 00-3643-BW-M3  (Dimmable 1-10V)

LED 18W A++ A  
 1728 lm 3000K

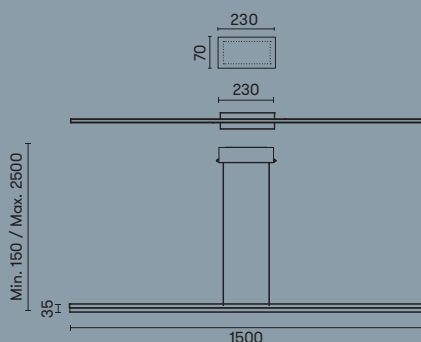

00-2935-BW-M3  (Standard)  
 00-3644-BW-M3  (Dimmable 1-10V)

LED 27W A++ A  
 2592 lm 3000K

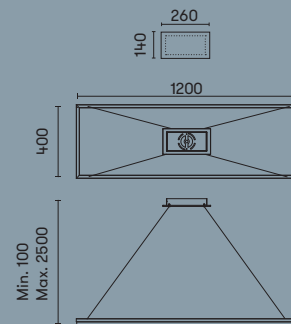

00-4876-BW-M3  (Standard)  
 00-4872-BW-M3  (Mains dimming)\*  220 240V

LED 34W A++ A  
 3264 lm 3000K

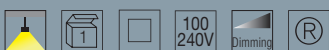

**Finishing | Acabados | Finitions**

**BW** Matt white | Blanco mate | Blanc mate

**Materials | Materiales | Matériaux**

**AL** Aluminium | Aluminio | Aluminium

**PMMA** Diffuser material PMMA | Material difusor PMMA | Matériau diffusant PMMA



71-2241-00-00

Controller with remote control for **Standard Version** | Controlador con mando a distancia para **Versiones Standard** | Contrôleur avec télécommande pour **Versions Standard**



\* Mains dimmer compatibility at [www.leds.c4.com](http://www.leds.c4.com) (Products & Downloads)

\* Compatibilidad con reguladores corte de fase en [www.leds.c4.com](http://www.leds.c4.com) (Productos & Descargas)

\* Compatible avec des variateurs en coupure de phase que vous pouvez consulter [www.leds.c4.com](http://www.leds.c4.com) (Produits & Téléchargements)

**Collection**

Illuminates your spaces alongside the other pieces that comprise this collection.

**Colección**

Ilumina tus espacios con el resto de piezas que componen esta colección.

**Collection**

Éclairiez vos espaces avec le reste des pièces de cette collection.



Floor  
Pie  
Pied p. 282



Ceiling  
Techo  
Plafond p. 304



Josep Patsí

---

# Net









# Net

**Purity.** Its flat, slimline design with very clean forms allows it to be used in various formats and applications within any space. Discreet, but at the same time versatile, this piece is available in a circular or oval shape.

**Pureza.** Su diseño plano, delgado y de formas muy limpias le permite varios formatos y aplicaciones en el espacio. Discreta y versátil al mismo tiempo, esta pieza está disponible en forma de circunferencia u óvalo.

**Pureté.** Son design plat, fin et aux formes très épurées lui permet d'adopter différents formats et applications dans l'espace. À la fois discret et polyvalent, ce modèle est disponible en forme de circonférence ou d'ovale.

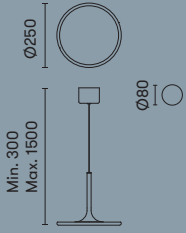

00-3685-BW-M1

LED 15W A++ A  
1440 lm 3000K

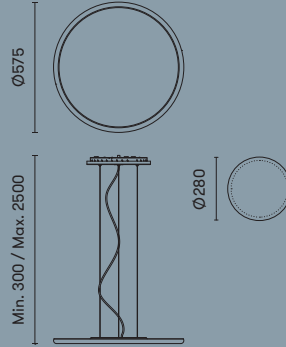

00-0003-BW-M1  (Standard)  
00-0643-BW-M1  (Dimmable 1-10V)

LED 44W A++ A  
4224 lm 3000K



71-2241-00-00

Controller with remote control for 00-0003 |  
Controlador con mando a distancia para 00-0003 |  
Contrôleur avec télécommande pour 00-0003



Dimmer | Regulador de intensidad |  
Régulateur d'intensité



Batteries included | Pilas incluidas | Piles  
fournies

132

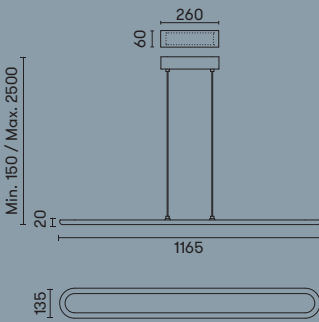

71-2241-00-00

Controller with remote control for 00-0779 |  
Controlador con mando a distancia para 00-0779 |  
Contrôleur avec télécommande pour 00-0779



Dimmer | Regulador de intensidad |  
Régulateur d'intensité



Batteries included | Pilas incluidas | Piles  
fournies



Finishing | Acabados | Finitions



BW Matt white | Blanco mate | Blanc mate

Materials | Materiales | Matériaux



AL Aluminium | Aluminio | Aluminium



PS DIF Diffuser material polystyrene | Material  
difusor Poliestireno | Matériau diffusant  
Polystyrène

00-0779-BW-M1  (Standard)  
00-0826-BW-M1  (Dimmable 1-10V)

LED 43W A++ A  
4128 lm 3000K



133

Josep Patsí

---

# Aura







# Aura

**Multifunctionality.** With its hemispherical composition and vertical ribbing, this piece provides a special light for any occasion. Its multifunctional light, effects and colour adapt to different ambiances and create multiple scenes.

**Multifuncionalidad.** De composición semiesférica con un estriado vertical, ofrece una iluminación especial para cada momento. Su iluminación multifunción, efectos y color, se adapta a diferentes atmósferas y crea múltiples escenas.

**Multifonctionnalité.** De composition semi-sphérique à stries verticales, ce luminaire assure un éclairage spécial pour chaque moment. Son éclairage multifonctionnel, ses effets et sa couleur permettent de l'adapter à différents décors et de créer de nombreuses mises en scène.

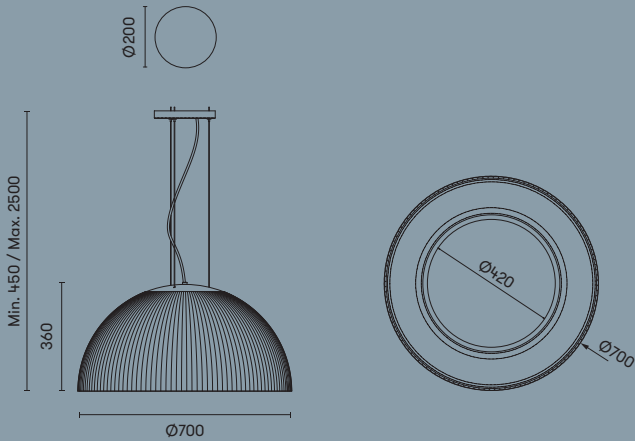

00-1942-BW-M3

LED 40W  
3840 lm 3000K  
LED 10W  
A+++ A  
RGB



## Finishing | Acabados | Finitions

BW Matt white | Blanco mate | Blanc mate

## Materials | Materiales | Matériaux

PMMA Diffuser material PMMA | Material difusor PMMA | Matériau diffusant PMMA

PUR Polyurethane | Poliuretano | Polyuréthane

Independent paired lighting system | Sistema de doble iluminación independiente | Système à double éclairage indépendant



Included



WIS Design

---

# Umbrella



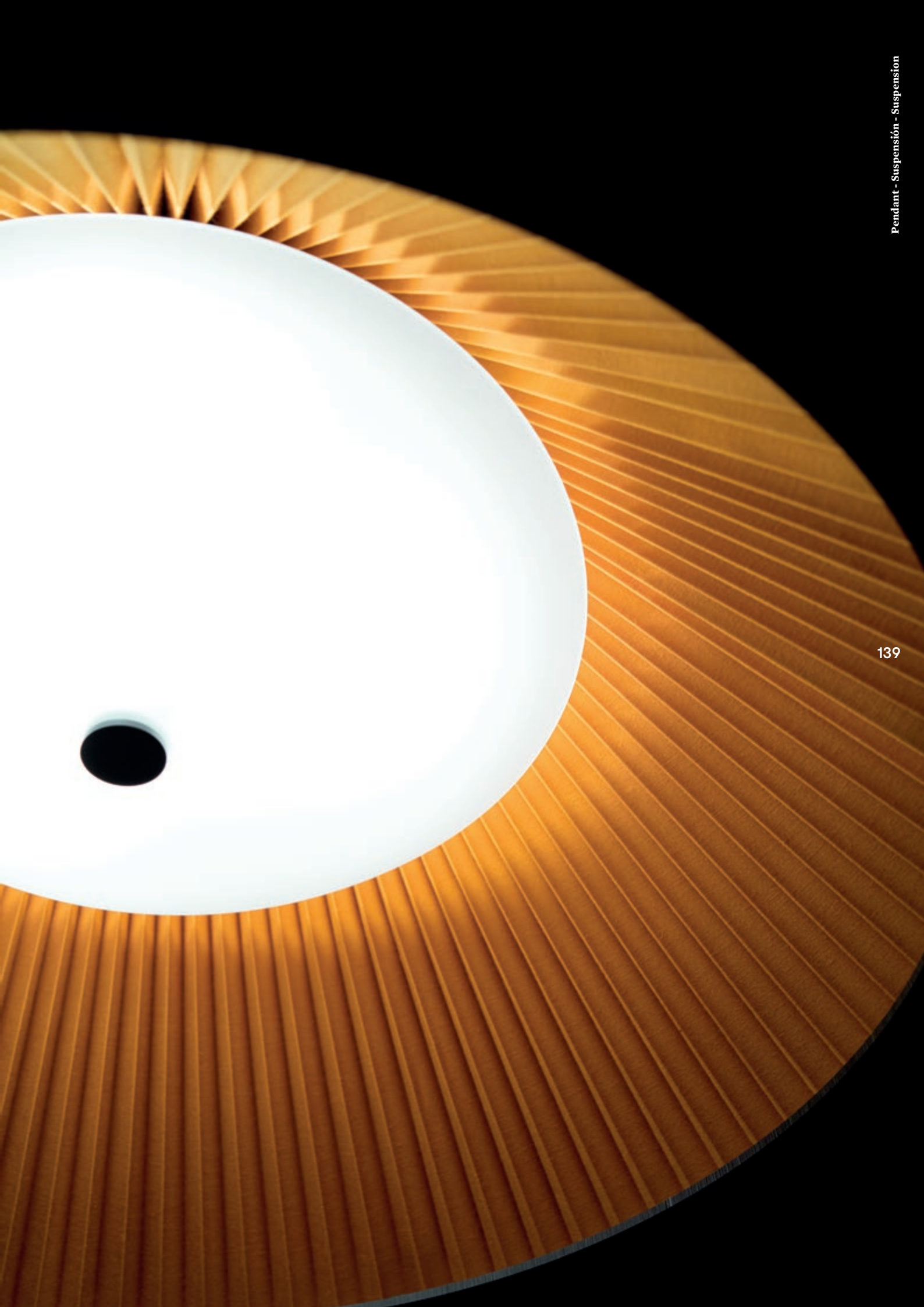



# Umbrella



**Radiant.** This luminaire draws its design inspiration from an umbrella on a sunny day, with the sun's rays shining through the fabric creating soft reflections of light. It is available in two sizes and two colour combinations: black and gold or white and silver.

**Radiante.** Esta luminaria debe su diseño a un paraguas en un día soleado en el que los rayos de sol atraviesan su tela creando suaves reflejos de luz. Está disponible en dos tamaños y en dos combinaciones de colores: negro/dorado o blanco/plata.

**Rayonnant.** Ce luminaire évoque un parasol qui laisse passer les rayons du soleil à travers son tissu, de manière à créer de doux reflets de lumière. Disponible en deux dimensions et deux combinaisons de couleur : noir/doré ou blanc/argenté.

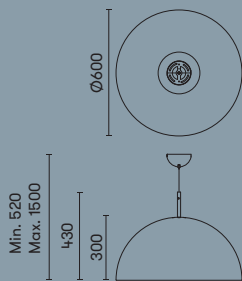
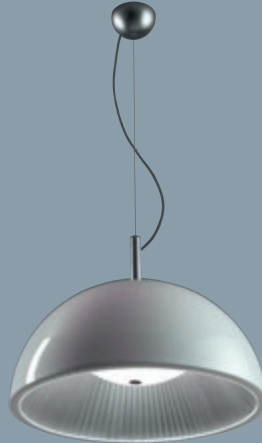

## Finishing | Acabados | Finitions

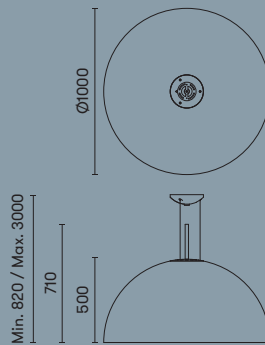

00-2727-AP-05   
00-2727-AQ-78 

3 x E-14 Max. 11W A++ C  
Max. L=145mm Ø=45mm  
Fluorescent - LED





00-2726-AP-05   
00-2726-AQ-78 

3 x E-27 Max. 23W A++ C  
Max. L=150mm Ø=60mm  
Fluorescent - LED



## Finishing | Acabados | Finitions

 **05** Black |  
Negro | Noir

+  **AP** Golden  
pleated interior  
shade | Pantalla  
interior plisada  
dorada | Intérieur  
d'abat-jour plissé  
doré

 **78** White  
lacquered |  
Lacado blanco |  
Laqué en blanc

+  **AQ** Metallic grey.  
Silver pleated  
interior shade |  
Gris metalizado.  
Pantalla interior  
plisada plata |  
Gris métallisé.  
Intérieur d'abat-  
jour plissé argenté

## Materials | Materiales | Matériaux

 Diffuser material matt glass | Material difusor  
vidrio mate | Matériau diffusant Verre

 PMMA | PMMA | PMMA

 Fabric | Tela | Tissu



142

Josep Patsí

---

# Angie



# Angie

**Magic.** Called “Angel wings” in Eastern cultures, its spherical composition and the effect of the light between its vertical slats creates a magical ambience. The elegant but bold design gives this piece great presence and personality.

**Magia.** Llamada “Alas de ángel” por los orientales, su composición esférica y el efecto de la luz entre sus lamas verticales crea ambientes mágicos. Su diseño elegante pero atrevido al mismo tiempo, la presenta como una pieza con mucha presencia y personalidad.



**Magique.** Appelé «Aile d’ange» en Orient, la composition de ce modèle sphérique et l’effet de sa lumière entre les lames verticales crée des ambiances magiques. Sa ligne élégante et audacieuse en fait un article à forte présence et personnalité.

## Finishing | Acabados | Finitions

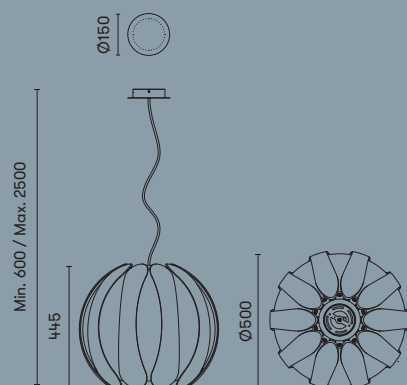

144





00-3543-BW-BW   
00-3543-F5-F5 

1 x E-27 Max. 100W A++ C  
Max. L=200mm Ø=150mm  
Fluorescent - LED



## Finishing | Acabados | Finitions

 **F5** Painted gold | Oro pintado | Or peint

 **BW** Matt white | Blanco mate | Blanc mate

## Materials | Materiales | Matériaux

 **ABS** ABS | ABS | ABS

 **ST** Steel | Acero | Acier



145

Nahtrang Disseny

---

# Spin







# Spin

**Kindness.** Its dual circular structure of silk wrapped around a central void makes it unique and singular. It is a classic piece in which forms and materials contrast to provide warmth in any space.



**Amabilidad.** Su doble estructura circular de seda encintada con un vacío central, la hace única y singular. Se trata de una pieza clásica en la que contrastan formas y materiales que aporta calidez en el espacio donde se coloca.

**Amabilité.** Sa double structure circulaire en soie avec un trou central la rend unique et singulière. C'est une pièce classique dans laquelle contrastent des formes et des matériaux qui apportent de la chaleur dans l'espace où elle est placée.





## Finishing | Acabados | Finitions



## Finishing | Acabados | Finitions



-  05 Black | Negro | Noir
-  14 White | Blanco | Blanc
-  21 Chrome | Cromo | Chrome

## Materials | Materiales | Matériaux

-  Diffuser material PMMA | Material difusor PMMA
-  PMMA | Matériau diffusant PMMA
-  Steel | Acero | Acier
-  Fabric | Tela | Tissue

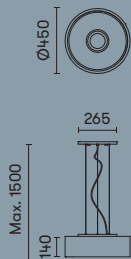

148



00-4601-21-05   
00-4601-21-14 

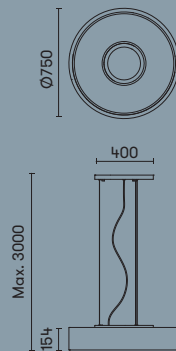

3 × E-27 Max. 23W A++ C  
Max. L=190mm Ø=60mm  
Fluorescent - LED

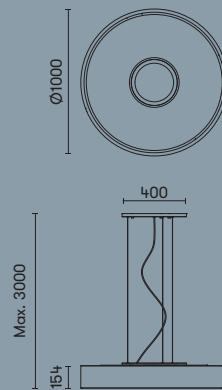

00-4607-21-05   
00-4607-21-14 

5 × E-27 Max. 30W A++ C  
Max. L=190mm Ø=60mm  
Fluorescent - LED



00-4615-21-05   
00-4615-21-14 

7 × E-27 Max. 30W A++ C  
Max. L=190mm Ø=60mm  
Fluorescent - LED

## Collection

Illuminates your spaces alongside the other pieces that comprise this collection.

## Colección

Ilumina tus espacios con el resto de piezas que componen esta colección.

## Collection

Éclairer vos espaces avec le reste des pièces de cette collection.



Ceiling  
Techo  
Plafond p. 308



Benedito Design

# Tandem

# Tandem

**Rational.** Evocative of timeless architecture, this pendant lamp includes a high-efficiency diffuser to produce warm and comfortable light. It is a reinterpretation of a classic design using LED technology.

**Racional.** Evocadora de arquetipos atemporales, esta lámpara colgante aporta un difusor de alta eficiencia para obtener una iluminación cálida y confortable. Se trata de una reinterpretación de un clásico con tecnología leds.

**Rationnel.** De ligne intemporelle, ce luminaire en suspension est muni d'un diffuseur à haute efficacité qui permet d'obtenir un éclairage chaleureux et confortable. Il s'agit d'une réinterprétation d'un classique avec la technologie LED.

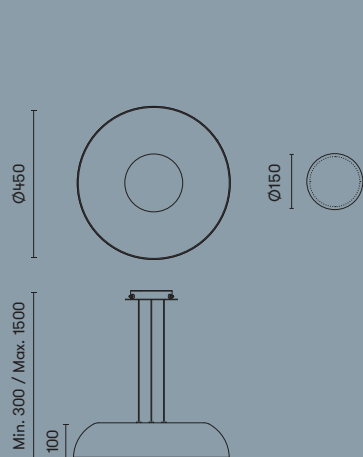

00-6008-BW-M1 

LED 15W  
1600 lm 2700K

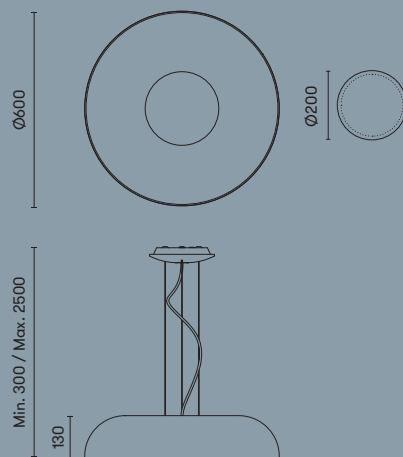

00-6009-BW-M1 

LED 27W  
2850 lm 2700K





## Finishing | Acabados | Finitions

 BW Matt white | Blanco mate | Blanc mate

## Materials | Materiales | Matériaux

 ST Steel | Acero | Acier

 PMMA Diffuser material PMMA | Material difusor PMMA  
 DIF PMMA | Matériau diffusant PMMA

## Collection

Illuminates your spaces alongside the other pieces that comprise this collection.

## Colección

Ilumina tus espacios con el resto de piezas que componen esta colección.

## Collection

Éclairez vos espaces avec le reste des pièces de cette collection.



Ceiling  
Techo  
Plafond p. 316



Gemma Bernal

---

# Bamboo



# Bamboo

**Honesty.** Made from fine, natural and eco-friendly materials, such as bamboo, they integrate perfectly into both warm and architectural spaces. Given their size, they can be installed in large spaces to create low-cost, efficient lighting.

**Honestidad.** Elaboradas con un producto noble, natural y ecológico como el bambú, se integran perfectamente en todos los espacios, tanto en cálidos como en arquitectónicos. Por sus dimensiones pueden instalarse en grandes espacios y generan una luz de bajo coste y suficiente.

**Honnêteté.** Issues d'un produit noble, naturel et biologique tel que le bambou, elles s'intègrent parfaitement dans tous les espaces aussi bien chauds et qu'architecturaux. Compte tenu des dimensions, elles peuvent être installées dans de grands espaces et génèrent une lumière suffisante à un faible coût.

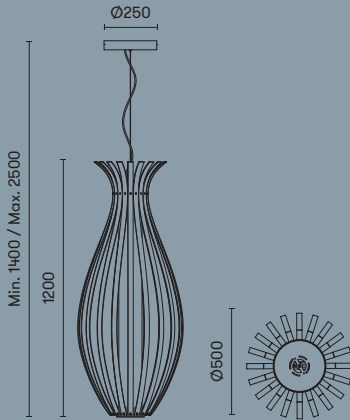

00-4034-CT-93 ■ (Dimmable 1-10V)

LED 22W A++ A  
1870 lm 3000K



Bamboo | Bambú | Bambou



## Finishing | Acabados | Finitions

CT Wood brown | Marrón madera | Bois marron

## Materials | Materiales | Matériaux

ST Steel | Acero | Acier

WOOD Wood | Madera | Bois

PMMA Diffuser material PMMA | Material difusor PMMA | Matériau diffusant PMMA

153

## Collection

Illuminates your spaces alongside the other pieces that comprise this collection.

## Colección

Ilumina tus espacios con el resto de piezas que componen esta colección.

## Collection

Éclairer vos espaces avec le reste des pièces de cette collection.



Floor  
Pie  
Pied p. 293



154

Josep Patsí

---

# Balloons



# Balloons



**Aesthetic.** With its spherical shape and composition, this luminaire combines different top-quality materials including blown opal glass, steel and fabric. These give its interior and exterior a discreet and elegant aesthetic.

**Estética.** De forma y composición esférica, esta luminaria combina diferentes materiales nobles como el vidrio ópalo soplado, el acero y el tejido. Todo ello la dota de una estética interior y exterior muy cuidada y sin protagonismos.

**Esthétique.** De forme et composition sphériques, ce luminaire décline différents matériaux nobles comme le verre opalin soufflé, l'acier et le tissu. Le tout lui confère une esthétique intérieure et extérieure très soignée en toute discrétion.

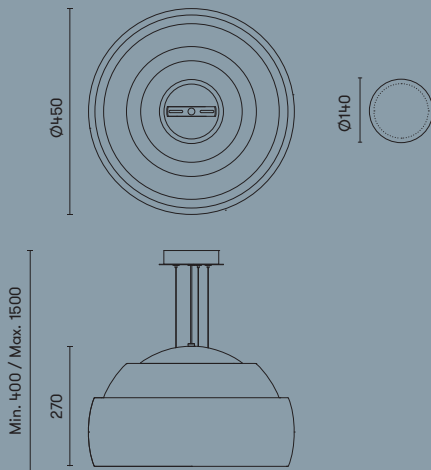
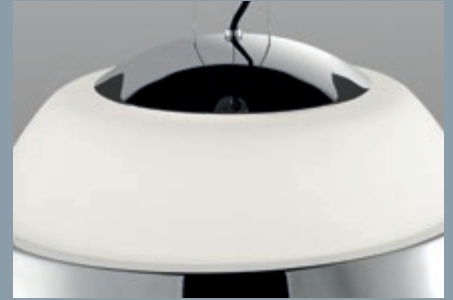
## Finishing | Acabados | Finitions



00-4348-21-F9   
00-4348-BW-F9 

1 x E-27 Max. 150W A++ C  
Max. L=195mm  $\Phi$ =60mm  
Fluorescent - LED



155

## Finishing | Acabados | Finitions

 21 Chrome | Cromo | Chrome

 BW Matt white | Blanco mate | Blanc mate

+

 White | Blanco | Blanc  
 Orange | Naranja | Orange  
 Green | Verde | Vert

## 00-4348-BW-F9

3 interchangeable indoor screens included |  
3 pantallas interiores intercambiables incluidas |  
3 abat-jour intérieurs et interchangeables inclus

## Materials | Materiales | Matériaux

 Diffuser material triplex Opal glass | Material difusor cristal opal triplex | Matériau diffusant verre opal triplex

 Steel | Acero | Acier

 Fabric | Tela | Tissu

Francesc Vilaró

---

# Ringofire





# Ringofire

**Comfort.** A reinterpretation and update to the traditional pendant lamp with LED technology. Its timeless design is suited for use in both domestic and contract spaces. The full-empty concept incorporated in its volumes gives it visual lightness and optimum lighting comfort.

**Confortabilidad.** Reinterpretación y actualización de las tradicionales lámparas de suspensión con tecnología led. Su diseño atemporal encaja tanto en el uso doméstico como en espacios contract. El concepto lleno-vacío en los volúmenes la dota de ligereza visual y de óptimo confort lumínico.

**Confort.** Réinterprétation et actualisation des traditionnelles lampes à suspension avec la technologie LED. Son design intemporel correspond aussi bien à un usage domestique qu'à des espaces professionnels. Les volumes de concept vide-plein lui donnent une légèreté visuelle optimale et un confort d'éclairage.

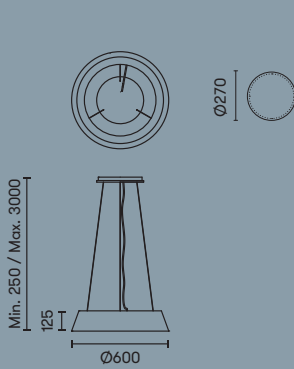

00-0053-05-BW

LED 26W A++ A  
974 lm 3000K

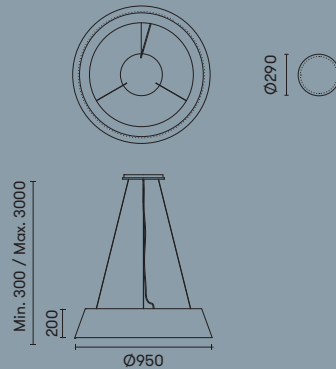

00-0054-05-BW

LED 41W A++ A    
1536 lm 3000K



Independent double lighting system | Sistema de doble iluminación independiente | Système double éclairage indépendant

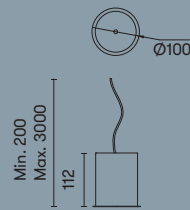

71-0053-BW-BW

1 x GU10 Max. 15W A++ C  
Max. L= 100mm Ø=111mm LED

Recommended:  
ACT-FLL-015 10W 24°  
ACT-FLL-017 10W 35°  
ACT-FLL-032 15W 24°  
ACT-FLL-033 15W 35°



## Finishing | Acabados | Finitions

05 Black | Negro | Noir

BW Matt white | Blanco mate | Blanc mate

## Materials | Materiales | Matériaux

ST Steel | Acero | Acier

PUR Polyurethane | Poliuretano | Polyuréthane



Nahrang Disseny

---

# Talk







# Talk

**Vibrancy.** A sky full of bright points of light appears when the daylight fades. Its vibrancy and geometry establish a connection between these points by creating its own language. Its compositions range from the basic minimum to the infinite. Hanging vines that can be used to fill all types of spaces.

**Dinamismo.** Un cielo de puntos brillantes aparecen cuando la luz del día cae. Su dinamismo y geometría establece una conexión entre ellos generando un lenguaje propio. Sus composiciones van desde el elemento mínimo hasta el infinito. Lianas colgantes que llenan todos los espacios.

**Dynamisme.** Un ciel de points brillants apparaît lorsque la lumière du jour tombe. Son dynamisme et sa géométrie établissent un lien entre eux créant un langage propre. Ses compositions vont de l'élément le plus minime à l'infini. Des lianes suspendues qui remplissent tous les espaces.

## Finishing | Acabados | Finitions

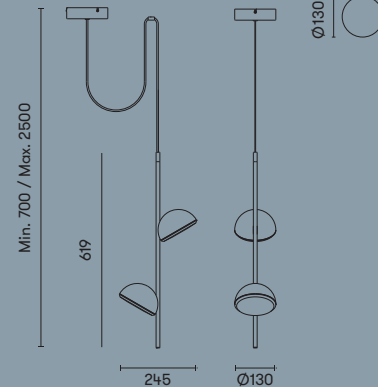
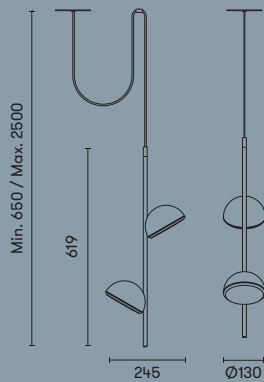
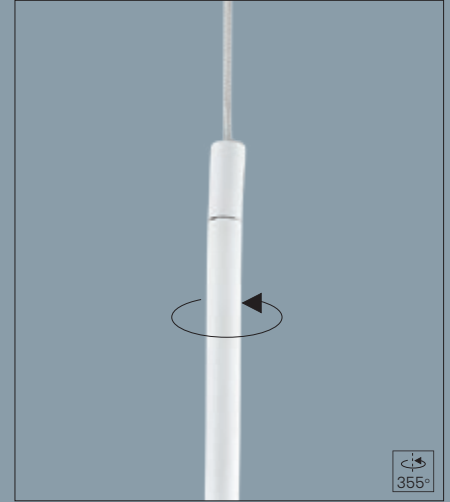
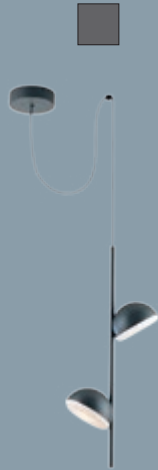

00-5458-BW-F9   
00-5458-Z5-F9

LED CREE 13W A++ A  
1390 lm 2700K



00-5457-BW-F9   
00-5457-Z5-F9

LED CREE 13W A++ A  
1390 lm 2700K



## Finishing | Acabados | Finitions

**BW** Matt white | Blanco mate | Blanc mate

**Z5** Anthracite grey | Gris antracita | Gris anthracite

## Materials | Materiales | Matériaux

AL Aluminium | Aluminio | Aluminium

GLASS Diffuser material glass | Material difusor vidrio | Matériau diffusant Verre

DIF

## Collection

Illuminates your spaces alongside the other pieces that comprise this collection.

## Colección

Ilumina tus espacios con el resto de piezas que componen esta colección.

## Collection

Éclairer vos espaces avec le reste des pièces de cette collection.



Wall  
Pared  
Mural p. 214



Table  
Sobremesa  
Table p. 262



Josep Patsí

---

# Clear

# Clear

**Feminine.** This light, fresh and timeless piece is characterised by its elegant feminine form. The purity of its lines, its lacquered finish and anti-glare diffuser makes this the ideal option for bar counters, shops or reception areas.

**Femenina.** Esta pieza ligera, fresca y atemporal se caracteriza por su forma femenina y elegante. La pureza de sus líneas, sus acabados lacados y el difusor anti alumbriamiento la propone como una luminaria perfecta para barras de bar, tiendas o recepciones.

**Féminin.** Léger, frais et intemporel, ce modèle se distingue par sa forme féminine et élégante. Lignes pures, finitions laquées et diffuseur anti-éblouissement sont autant d'atouts qui en font le luminaire idéal pour les comptoirs de bar, de magasins ou de halls d'accueil.

## Finishing | Acabados | Finitions

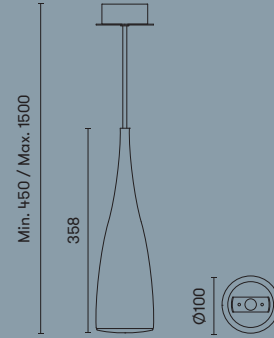

00-2872-05-M2 ■  
 00-2872-78-M2 □  
 1 × E-27 | Par-20 Max. 50W A++ C  
 Max. L=170mm Ø=64mm  
 Fluorescent - LED  
 Recommended E-27 PAR-20 50W

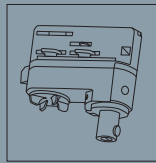

71-2232-14-14  
 Track Connector |  
 Conector de Carril |  
 Connecteur de Rail

Top diffuser | Difusor Superior | Diffuseur Supérieur



## Finishing | Acabados | Finitions

05 Black | Negro | Noir

78 White lacquered | Lacado blanco |  
 Laqué en blanc

## Materials | Materiales | Matériaux

ST Steel | Acero | Acier

PC Diffuser material polycarbonate | Material  
 difusor Policarbonato | Matériau diffusant  
 Polycarbonate



Francesc Vilaró

---

# Emy



# Emy

**Elegance.** With classical and elegant forms, its design is based on the use of materials and the effects generated by the light on them. The carefully designed shape of its polycarbonate lampshade creates the almost holographic effect of a second lampshade inside.

**Elegancia.** De formas clásicas y elegantes, su diseño se basa en el uso de los materiales y los efectos que genera la luz sobre ellos. Su estudiada trama de la pantalla de policarbonato genera un efecto de casi holograma de la segunda pantalla interior.

**Élégance.** Aux formes classiques et élégantes, son design est basé sur l'utilisation de matériaux et les effets générés par la lumière sur ceux-ci. La trame étudiée de l'écran en polycarbonate génère un effet d'hologramme du second écran interne.

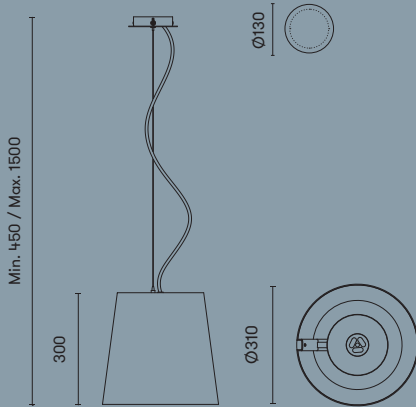

00-4409-21-12

1 x E-27 Max. 30W A++ C  
Max. L=180mm Ø=60mm  
Fluorescent - LED



## Finishing | Acabados | Finitions

**SHADE** 12 Smoked acrylic shade | Pantalla acrílico fumé | Abat-jour acrylique fumé

**21** Chrome | Cromo | Chrome

## Materials | Materiales | Matériaux

**AL** Aluminium | Aluminio | Aluminium

**PMMA** Diffuser material PMMA | Material difusor PMMA | Matériau diffusant PMMA

**PC** Shade material Polycarbonate | Material pantalla Polycarbonato | Matériels Abat-jour Polycarbonate

## Collection

Illuminates your spaces alongside the other pieces that comprise this collection.

## Colección

Ilumina tus espacios con el resto de piezas que componen esta colección.

## Collection

Éclairiez vos espaces avec le reste des pièces de cette collection.



Wall  
Pared  
Mural p. 217



Table  
Sobremesa  
Table p. 264



Floor  
Pie  
Pied p. 296



Josep Patsí

---

# Sixties





# Sixties

**Vintage.** With a look that's somewhere between Nordic and vintage, these three pendant lights are suitable for all kinds of spaces and can be placed either separately or together. The Sixties style, maintaining elegance and formal simplicity, and their direct, focused light makes them ideal for hotels, restaurants and shops.

**Vintage.** Con un aire entre nórdico y vintage, estas tres piezas colgantes se adaptan a todos los espacios colocándolas solas o combinadas. De estilo años 60, mantienen la elegancia y la simplicidad formal y su iluminación directa y focalizada la hace perfecta para hoteles, restaurantes y tiendas.

**Vintage.** Dotées d'un air à la fois nordique et vintage, ces trois pièces suspendues s'adaptent à tous les espaces, seules ou combinées. De style années soixante, ces modèles élégants aux formes simples offrent un éclairage direct et focalisé qui les rendent idéaux dans l'hôtellerie, la restauration et le commerce.

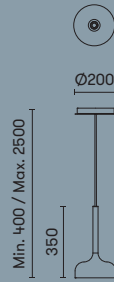

00-5939-CI-CI ■

LED CREE 11W  
1050 lm 3000K

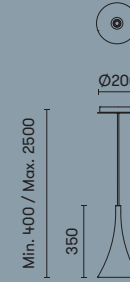

00-5938-CI-CI ■

LED CREE 11W  
1050 lm 3000K

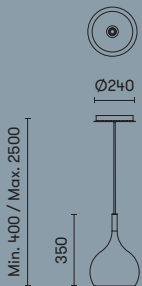

00-5937-CI-CI ■

LED CREE 11W  
1050 lm 3000K

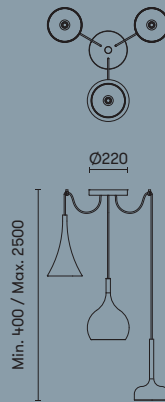

00-5940-CI-CI ■

LED CREE 35W  
3150 lm 3000K



**Finishing | Acabados | Finitions**

■ CI Brown | Marrón | Marron + ■ 06 Copper | Cobre | Cuivre

**Materials | Materiales | Matériaux**

■ ST Steel | Acero | Acier

■ PMMA Diffuser material PMMA | Material difusor PMMA | Matériau diffusant PMMA



172

Josep Patsí

---

# Stream

# Stream

**Slenderness.** The linear design of this lamp makes it appear lightweight and slender. It owes its personality to the interspersed ripples that provide the texture on its lateral surfaces.

**Esbeltez.** El formato lineal de su diseño dota a esta lámpara de suspensión de una sensación de ligereza y esbeltez. Su personalidad se debe a las ondulaciones entrecortadas que crean la textura de sus superficies laterales.

**Sveltezza.** Le format linéaire de son design dote cette suspension d'une sensation de légèreté et de sveltesse. Ce modèle doit sa personnalité aux ondulations entrecroisées qui créent la texture de ses surfaces latérales.

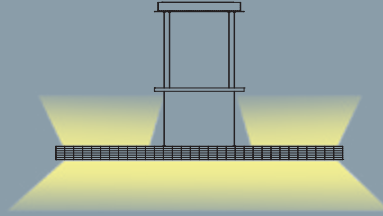
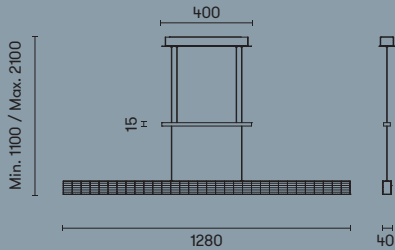

## Finishing | Acabados | Finitions

BW Matt white | Blanco mate | Blanc mate

## Materials | Materiales | Matériaux

AL Aluminium | Aluminio | Aluminium

PUR Polyurethane | Poliuretano | Polyuréthane

PMMA Diffuser material PMMA | Material difusor PMMA  
 DIF PMMA | Matériau diffusant PMMA

00-2924-BW-M1

LED 27.5W (Down) 2640 lm  
 LED 12.5W (Up) 1200 lm A++ A  
 3000K

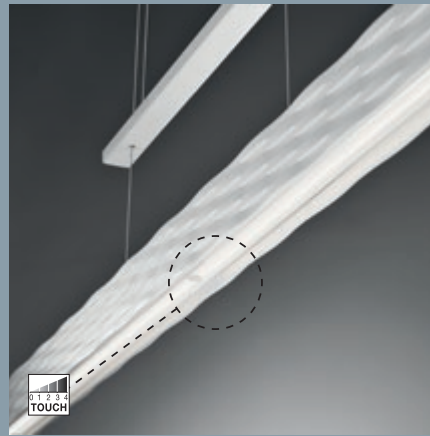
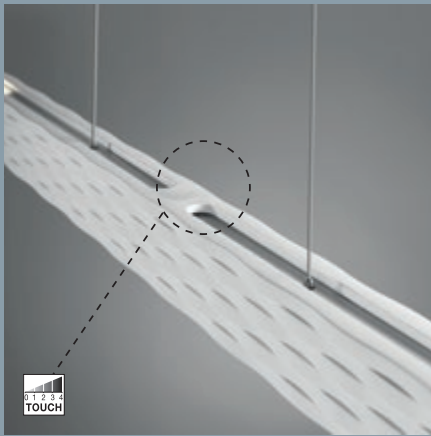

Independent paired lighting system | Sistema de doble iluminación independiente | Système à double éclairage indépendant



Estudi Ribaudí

---

# Tulip

# Tulip

**Mysterious.** The plant-like morphology of this luminaire explores organic forms. The spiral connection of its petals creates a mysteriously asymmetrical yet harmonic and natural piece.

**Misteriosa.** La morfología vegetal de esta luminaria en suspensión explora las formas orgánicas. La conexión en espiral de sus pétalos crea una figura misteriosamente asimétrica pero armónica y natural al mismo tiempo.

**Mystérieux.** La morphologie végétale de ce luminaire en suspension explore les formes organiques. La disposition en spirale de ses pétales crée une figure mystérieusement asymétrique qui reste cependant harmonieuse et naturelle.

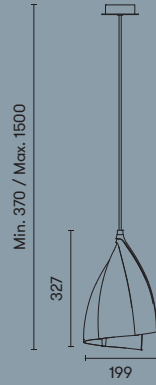

00-4416-05-23 ■

1 × E-27 Max. 23W A++ C  
 Max. L=150mm Ø=60mm  
 Fluorescent - LED

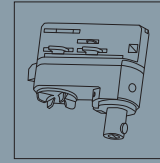

71-2232-14-14  
 Track Connector |  
 Conector de Carril |  
 Connecteur de Rail



## Finishing | Acabados | Finitions

05 Black | Negro | Noir + 23 Golden | Dorado | Doré

## Materials | Materiales | Matériaux

ABS ABS | ABS | ABS



Benedito Design

---

# Twins

# Twins

**Levity.** The simple geometry of this luminaire features an audacious opening in the side of its components to lend it a certain vibrancy. This glass-on-metal dual-material pendant lamp brings a sensation of levity to the atmosphere, giving the space a certain singularity and distinction.

**Levedad.** Esta luminaria de geometría sencilla se caracteriza por un corte audaz en el perfil lateral de sus piezas que le imprime dinamismo. Este colgante bi-material, vidrio sobre metal, aporta a la atmósfera una sensación de levedad que dota al espacio de singularidad y distinción.

**Légèreté.** Ce luminaire à la géométrie simple se caractérise par une coupe audacieuse dans le profil latéral de ses pièces qui lui apporte du dynamisme. Cette suspension bi-matière, du verre sur du métal, confère à l'atmosphère une sensation de légèreté qui donne à l'espace un caractère différent et singulier.

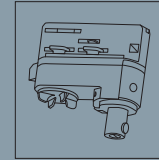
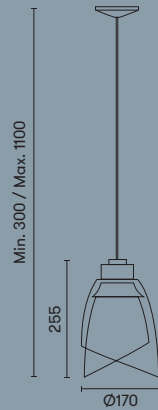

**71-2232-14-14**  
Track Connector |  
Conector de Carril |  
Connecteur de Rail

00-0087-N3-F9 

1 × E-27 Max. 100W A++ C  
Max. L=150mm Ø=60mm  
Fluorescent - LED



## Finishing | Acabados | Finitions



**N3** Grey texture | Gris textura |  
Gris à effet de texture

## Materials | Materiales | Matériaux



Steel | Acero | Acier



Diffuser material optic glass | Material difusor  
cristal óptico | Matériau diffusant verre optique



Diffuser material transparent glass | Material  
difusor cristal transparente | Matériau  
diffusant verre transparent







<u>Wall</u>	Invisible	180	Talk	214
<u>Pared</u>	Big Bang	184	Emy	217
<u>Mural</u>	Prime	188	Skata	220
	Rizz	194	Igloo	222
	Bend	198	Suite	224
	Surf	202	Wave	226
	Flavia	206	Flat	228
	Hall	210		



Francesc Vilaró

---

# Invisible





# Invisible

**Authenticity.** The unique, timeless and versatile design of this collection means it can be adapted to suit all types of spaces. The flexibility of its parts enables the light to be controlled easily and directed wherever it is needed.

**Autenticidad.** El diseño propio, atemporal y versátil permite que esta colección se adapte a todo tipo de espacios. La flexibilidad de sus piezas permite controlar fácilmente la luz y direccionarla donde sea necesario.

**Authenticité.** Le design épuré, intemporel et polyvalent permet à cette collection de s'adapter à tous les types d'espaces. La flexibilité des différentes pièces permet de contrôler facilement la lumière et de la diriger en cas de besoin.

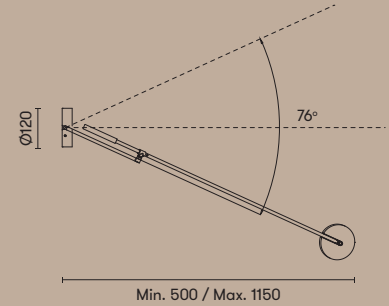
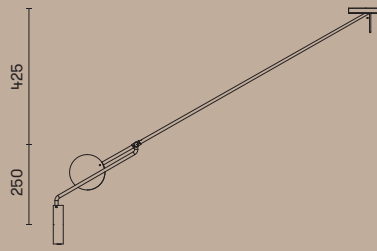
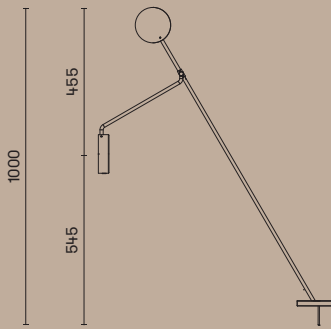

05-5693-05-05 ■

LED 9W A++ A  
765lm 3000K

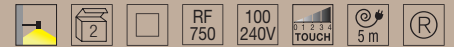

183

## Finishing | Acabados | Finitions

05 Black | Negro | Noir

## Materials | Materiales | Matériaux

AL Aluminium | Aluminio | Aluminium

PMMA Diffuser material PMMA | Material difusor PMMA | Matériau diffusant PMMA

## Collection

Illuminates your spaces alongside the other pieces that comprise this collection.

## Colección

Ilumina tus espacios con el resto de piezas que componen esta colección.

## Collection

Éclairiez vos espaces avec le reste des pièces de cette collection.



Pendant  
Suspensión  
Suspension p. 94



Table  
Sobremesa  
Table p. 244

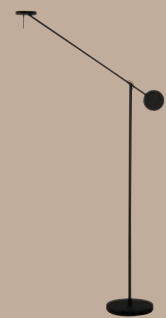

Floor  
Pie  
Pied p. 268



Francesc Vilaró

---

# Big Bang







# Big Bang

**Sensuality.** This appealing wall lamp with LED technology is a sensory explosion of light. The indirect light generated by this luminaire is reflected onto gold-coloured metal creating a sensual halo of light that produces different effects by day or night.

**Sensualidad.** Este sugerente aplique con tecnología led es un estallido sensorial de luz. La luz indirecta que genera esta luminaria se refleja sobre una pieza de metal dorado que crea un halo lumínico sensual produciendo diferentes efectos de día o de noche.

**Sensualité.** Cette applique suggestive dotée de la technologie LED est une explosion sensorielle de lumière. La lumière indirecte générée par ce luminaire est réfléchiée sur une pièce de métal dorée qui crée un halo lumineux sensuel produisant différents effets de jour ou de nuit.

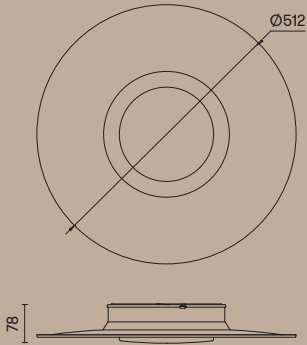

05-5085-BW-BW

LED 9W (Back) 765 lm 3000K

+

LED 13,5W (Front) A++ A 1147 lm 3000K



## Finishing | Acabados | Finitions

<div style="display: flex; align-items: center;"> <div style="width: 20px; height: 20px; background-color: white; border: 1px solid black; margin-right: 5px;"></div> <div> <p><b>BW</b> Matt white   Blanco mate   Blanc mate</p> </div> </div>	+	<div style="display: flex; align-items: center;"> <div style="width: 20px; height: 20px; background-color: #c48030; border: 1px solid black; margin-right: 5px;"></div> <div> <p><b>27</b> Matt satin finished brass   Latón satinado mate   Laiton satiné mat</p> </div> </div>
--	---	--

## Materials | Materiales | Matériaux

**AL** Aluminium | Aluminio | Aluminium

**PMMA** Diffuser material PMMA | Material difusor  
**DIF** PMMA | Matériau diffusant PMMA



Josep Patsí

---

**Prime**



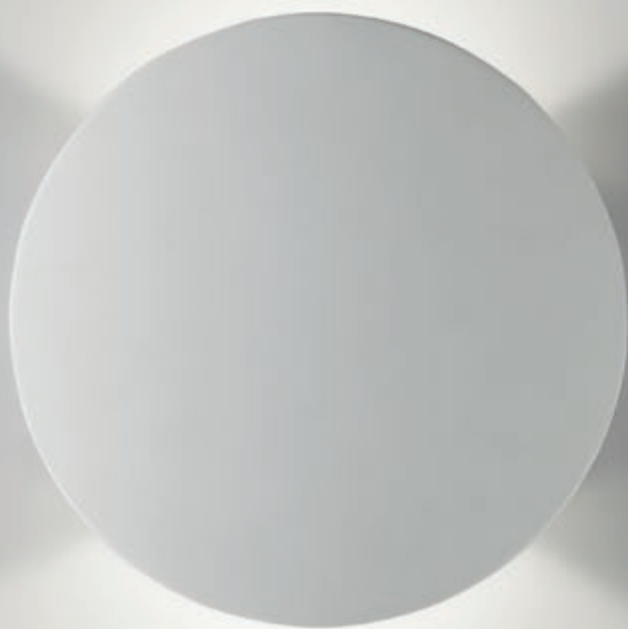





# Prime

**Power.** It is a fundamental and necessary piece in any interior design project because its simple geometry easily integrates into any space. It combines simplicity and delicacy of form with the most powerful LED lighting available on the market.

**Potencia.** Es una pieza básica y necesaria en todo proyecto de interior por su geometría simple y fácil de integrar en cualquier espacio. Combina la simplicidad y la suavidad de sus formas con la iluminación led más potente y disponible del mercado.

**Puissance.** C'est une pièce de base nécessaire dans tout projet d'intérieur de par sa géométrie simple et facile à intégrer dans tous les espaces. Il allie la simplicité et la douceur de ses formes avec l'éclairage LED le plus puissant disponible sur le marché.

## Finishing | Acabados | Finitions

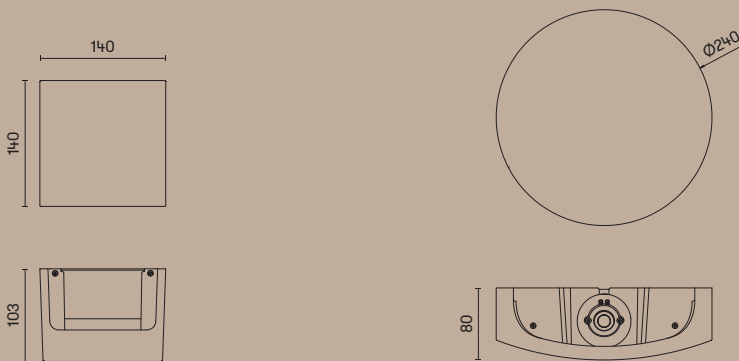

05-5956-BW-BW   
05-5956-Z5-Z5  (Mains dimming)\*

LED 40W A++ A  
4000 lm 3000K





05-5957-BW-BW   
05-5957-Z5-Z5  (Mains dimming)\*

LED 20W A++ A  
4000 lm 3000K



## Finishing | Acabados | Finitions

 **BW** Matt white | Blanco mate | Blanc mate

 **Z5** Anthracite grey | Gris antracita | Gris anthracite

## Materials | Materiales | Matériaux

 **AL** Aluminium | Aluminio | Aluminium

\* Mains dimmer compatibility at [www.leds.c4.com](http://www.leds.c4.com) (Products & Downloads)

\* Compatibilidad con reguladores corte de fase en [www.leds-c4.com](http://www.leds-c4.com) (Productos & Descargas)

\* Compatible avec des variateurs en coupure de phase que vous pouvez consulter [www.leds-c4.com](http://www.leds-c4.com) (Produits & Téléchargements)



Ramón Valls

---

**Rizz**







# Rizz

**Integration.** The various finishes and measurements of these luminaires facilitates their incorporation into any space regardless of its decorative style, filling it with different visual and lighting appearances.

**Integración.** Los diferentes acabados y medidas de estas luminarias permiten su mejor incorporación en los espacios, independientemente de su estilo decorativo, llenándolos con diversos aspectos visuales y lumínicos.

**Intégration.** Les différentes finitions et tailles de ces luminaires permettent une meilleure intégration dans les espaces, quel que soit leur style décoratif, en leur apportant différents aspects visuels d'éclairage.

## Finishing | Acabados | Finitions



## Finishing | Acabados | Finitions

- AF** Satin aluminium | Aluminio satinado | Aluminium satiné
- 27** Matt satin finished brass | Latón satinado mate | Laiton satiné mat
- BW** Matt white | Blanco mate | Blanc mate

## Materials | Materiales | Matériaux

- AL Aluminium | Aluminio | Aluminium
- PMMA Diffuser material PMMA | Material difusor PMMA
- DIF PMMA | Matériau diffusant PMMA

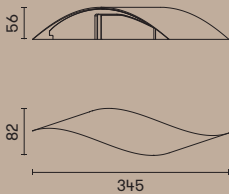

- 05-1819-AF-AF
- 05-1819-27-27
- 05-1819-BW-BW

LED CREE 6W A++ A  
510 lm 3000K

### 05-1817-AF-AF

1 x R7s L=78 Max. 80W A++ C  
OSRAM included

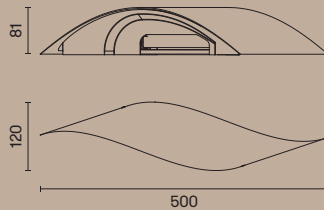

- 05-1822-AF-AF
- 05-1822-27-27
- 05-1822-BW-BW

LED CREE 18,3W A++ A  
1380 lm 3000K

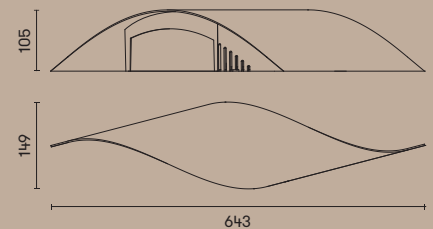

- 05-5969-BW-BW
- 05-5969-AF-AF
- 05-6016-BW-BW  (Mains dimming)\*
- 05-6016-AF-AF  (Mains dimming)\*

LED CREE 30.7W  
2300 lm 3000K

\* Mains dimmer compatibility at [www.leds-c4.com](http://www.leds-c4.com) (Products & Downloads)

\* Compatibilidad con reguladores corte de fase en [www.leds-c4.com](http://www.leds-c4.com) (Productos & Descargas)

\* Compatible avec des variateurs en coupure de phase que vous pouvez consulter [www.leds-c4.com](http://www.leds-c4.com) (Produits & Téléchargements)



Its special design allows for multiple combinations. Su especial diseño permite múltiples combinaciones. Son design spécial permet de nombreuses combinaisons.

Connection scheme. Esquema de conexión. Schéma de connexion.



Benedito Design

---

# Bend





# Bend



**Functionality.** With forceful straight lines, this front-facing wall lamp is focused in the centre and expands outwards to increase the dimensions of the two windows at the sides. The inclination of these windows controls the distribution of the light halo to give it a strong personality.

**Funcionalidad.** De formas lineales y contundentes, este aplique frontal se ciñe en el centro y se expande hacia los límites para incrementar la dimensión de las dos ventanas situadas en los extremos. La inclinación de estas orienta la difusión del halo luminoso dotándola de una fuerte personalidad.

**Fonctionnalité.** Aux formes linéaires et contondantes, cette applique frontale se tient au centre et s'élargit vers les limites pour augmenter la taille des deux fenêtres situées aux extrémités. L'inclinaison de celles-ci oriente la diffusion du halo lumineux en lui donnant une forte personnalité.

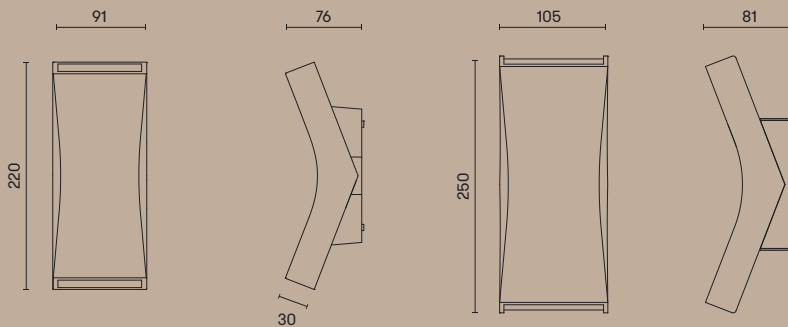
## Finishing | Acabados | Finitions



05-4394-78-M1   
05-4394-AH-M1 

LED CREE 4,5W A++ A  
880 lm 3000K







05-5954-BW-M1  (Mains dimming)\*  
05-5954-Z5-M1  (Mains dimming)\*



LED CREE 9W A++ A  
1920 lm 3000K



## Finishing | Acabados | Finitions

-  **BW** Matt white | Blanco mate | Blanc mate
-  **78** White lacquered | Lacado blanco | Laqué en blanc
-  **AH** Ecobright aluminium | Aluminio ecobright | Aluminium Ecobright
-  **Z5** Anthracite grey | Gris antracita | Gris anthracite

## Materials | Materiales | Matériaux

-  **AL** Aluminium | Aluminio | Aluminium
-  **PMMA** Diffuser material PMMA | Material difusor PMMA | Matériau diffusant PMMA

\* Mains dimmer compatibility at [www.leds-c4.com](http://www.leds-c4.com) (Products & Downloads)

\* Compatibilidad con reguladores corte de fase en [www.leds-c4.com](http://www.leds-c4.com) (Productos & Descargas)

\* Compatible avec des variateurs en coupure de phase que vous pouvez consulter [www.leds-c4.com](http://www.leds-c4.com) (Produits & Téléchargements)



Josep Patsí

---

# Surf



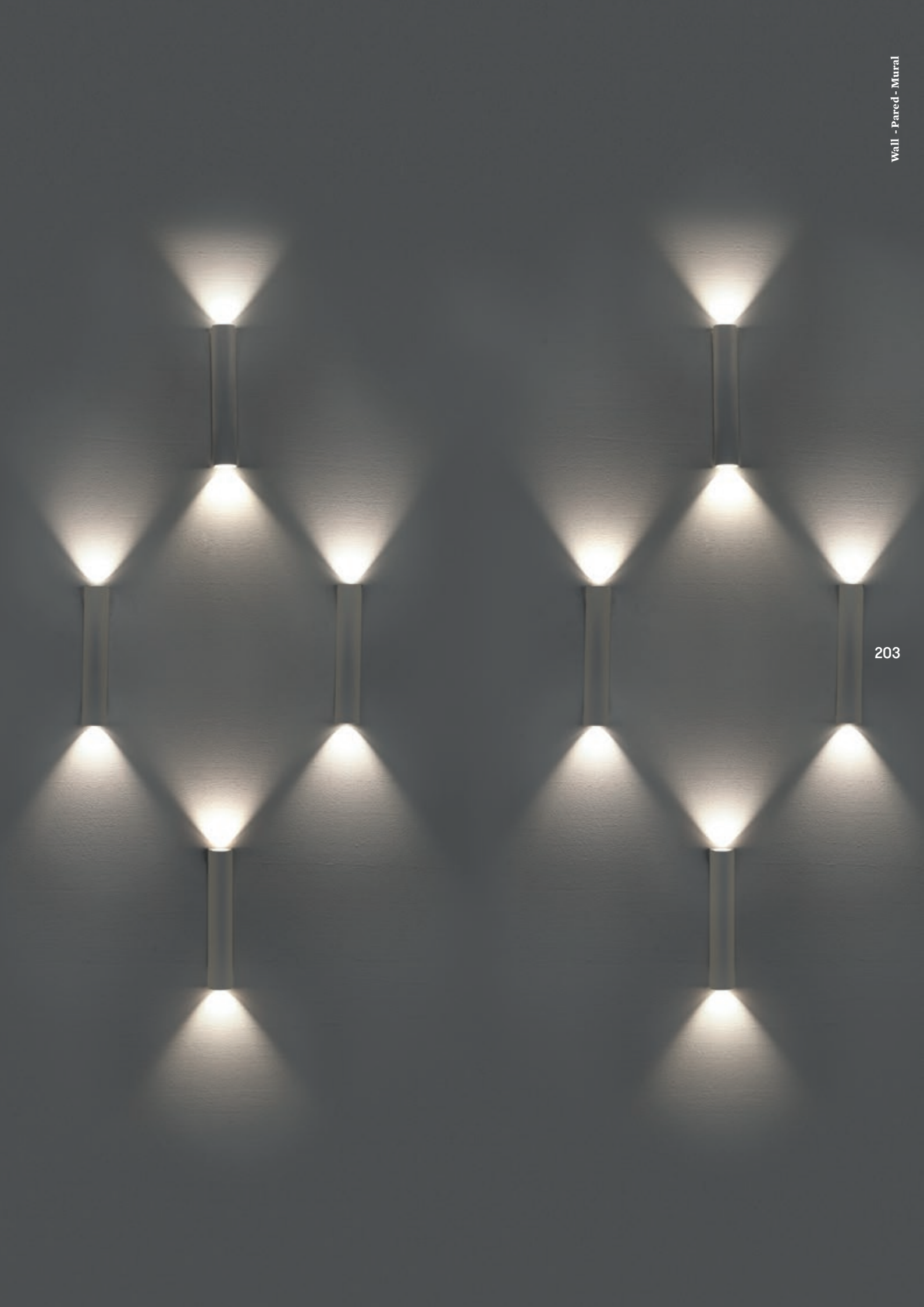



# Surf

**Diversity.** These lamps can be installed individually or in multiple compositions in response to the needs of each space. It has the capacity to fill a space and generate a variety of visual and lighting results.

**Diversidad.** Estas lámparas pueden instalarse de manera individual o formando múltiples composiciones dando respuesta a las necesidades de cada espacio. Tienen la capacidad de llenar el espacio generando diversos aspectos visuales y lumínicos.

**Diversité.** Ces lampes peuvent être installées individuellement où former plusieurs compositions pour répondre aux besoins de chaque espace. Elles ont la capacité de remplir l'espace en créant divers aspects visuels d'éclairage.

## Finishing | Acabados | Finitions

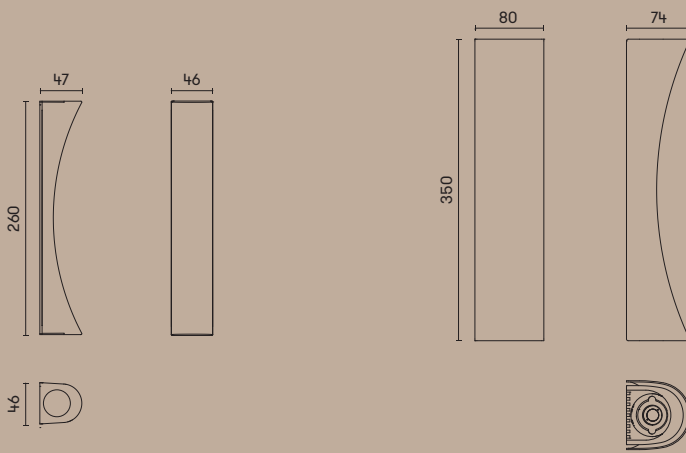

## Finishing | Acabados | Finitions

 **21** Chrome | Cromo | Chrome

 **BW** Matt white | Blanco mate | Blanc mate

## Materials | Materiales | Matériaux



 Aluminium | Aluminio | Aluminium

 Diffuser material PMMA | Material difusor PMMA | Matériau diffusant PMMA

\*\* Mains dimmer compatibility at [www.leds-c4.com](http://www.leds-c4.com) (Products & Downloads)

\*\* Compatibilidad con reguladores corte de fase en [www.leds-c4.com](http://www.leds-c4.com) (Productos & Descargas)

\*\* Compatible avec des variateurs en coupure de phase que vous pouvez consulter [www.leds-c4.com](http://www.leds-c4.com) (Produits & Téléchargements)

05-5077-BW-BW\*   
05-5077-21-21\* 

LED 4,5W A++ A  
1000 lm 3000K



05-5968-BW-BW  (Mains dimming)\*\*  
05-5968-21-21  (Mains dimming)\*\*

LED 10W A++ A  
2000 lm 3000K



\* It includes 2 interchangeable diffusers.  
\* Incluye dos difusores intercambiables.  
\* Comprend deux diffuseurs interchangeables.







# Flavia

**Distinction.** With an unforgettable design that stands out from the rest, the shape of this luminaire is based on an audacious gesture, a touch of distinction, making it ideal for residential and hotel environments.

**Distinción.** Con un diseño para recordar y diferenciarse, la forma de esta luminaria se basa en un gesto audaz, en un toque de distinción, pensada para entornos residenciales y hoteleros.

**Distinction.** Avec un design différent dont on se souviendra, la forme de ce luminaire part d'un geste audacieux, d'une touche de classe, conçue pour les environnements résidentiels et hôteliers.

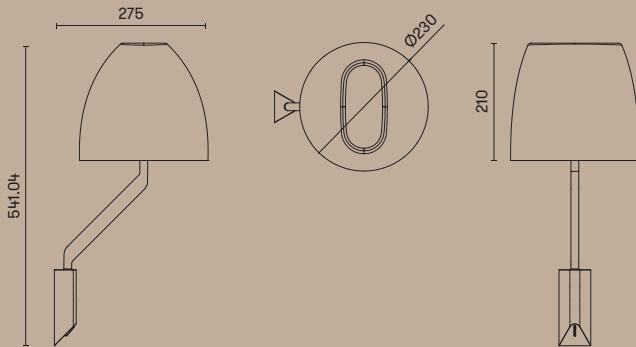

## Finishing | Acabados | Finitions

**21** Chrome | Cromo | Chrome

## Materials | Materiales | Matériaux

**ZAMAK** Zamak | Zamak | Zamak

**PMMA** Shade material PMMA | Material pantalla PMMA | Matériels abat-jour PMMA

05-3686-21-M1

1 x E-27 Max. 18W A++ C  
Max. L=125mm Ø=78mm  
Fluorescent - LED

## Collection

Illuminates your spaces alongside the other pieces that comprise this collection.

## Colección

Ilumina tus espacios con el resto de piezas que componen esta colección.

## Collection

Éclairiez vos espaces avec le reste des pièces de cette collection.



Table  
Sobremesa  
Table p. 258

Floor  
Pie  
Pied p. 286

210



Nahtrang Disseny

---

# Hall





# Hall

**Simplicity.** With a contemporary style, this wall lamp is the centrepiece of a family that is designed and created to meet the needs of hotels. Its careful lines and shapes, and square cross-section, make this luminaire a unique piece.

**Simplicidad.** De diseño contemporáneo, este aplique es el núcleo de una familia ideada y creada para cubrir las necesidades de los hoteles. Sus líneas y formas cuidadas, y de sección cuadrada, hacen a esta luminaria una pieza única.

**Simplicité.** Au design contemporain, cette applique est au cœur d'une gamme conçue et pensée pour répondre aux besoins des hôtels. Ses lignes, ses formes soignées, et sa section carrée font de ce luminaire une pièce unique.

## 1-Step

Choose the structure in the finish that best suits you. Elige la estructura en el acabado que más te guste. Choisissez la structure dans la finition que vous préférez.

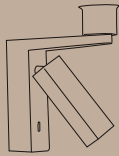

+

## 2-Step

Select the shape, size and finish of the shade. You can see our recommendations on the following pages. Elige la forma, tamaño y acabado de la pantalla. Verás nuestras recomendaciones en las páginas siguientes. Choisissez la forme, la dimension et la finition de l'abat-jour. Vous trouverez nos recommandations dans les pages suivantes.

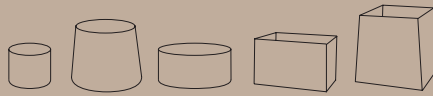

## 3-Step

Your lamp is now ready! ¡Tu lámpara está lista! Votre lampe est prête !



## Round shades Pantallas redondas Abat-jour ronds



### Finishing | Acabados | Finitions

- 14 White | Blanco | Blanc
- BY Beige | Beige | Beige
- AJ Opera grey | Gris ópera | Gris opéra

## Squared shades Pantallas cuadradas Abat-jour carrés

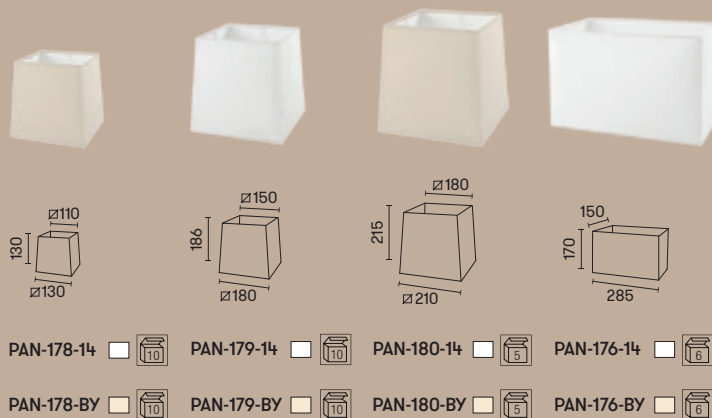

### Finishing | Acabados | Finitions

- 14 White | Blanco | Blanc
- BY Beige | Beige | Beige

LEDS C4 offers you the possibility to entirely customize the shades, choosing the shape, size, material and the most appropriate design for each atmosphere. |

LEDS C4 te ofrece la posibilidad de personalizar totalmente las pantallas, eligiendo la forma, el tamaño, el material y el acabado más idóneo para cada ambiente. |

LEDS C4 vous offre la possibilité de personnaliser totalement les abat-jour en choisissant la forme, la dimension, la matière et la finition qui convient le mieux à chaque espace.



Finishing | Acabados | Finitions

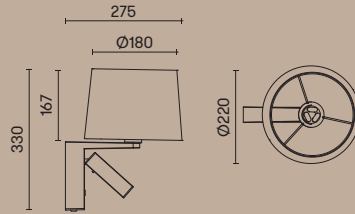

05-1941-BW-82  + PAN  
 05-1941-81-82  + PAN

1 x E-27 Max. 60W  
 Max. L=130mm Ø=60mm  
 Halogen - Fluorescent - LED  
 LED CREE 3W A++ C  
 162 lm 3000K



Finishing | Acabados | Finitions

- BW** Matt white | Blanco mate | Blanc mate
- 81** Satin nickel | Níquel satinado | Nickel satiné

Materials | Materiales | Matériaux

- AL** Aluminium | Aluminio | Aluminium
- TEXTIL** Shade material fabric | Material pantalla tela
- SHADE** | Matériels abat-jour tissu

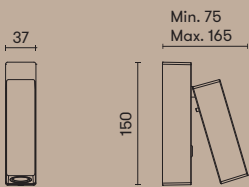

05-1940-BW-BW   
 05-1940-81-81

LED CREE 3W A++ C  
 162 lm 3000K

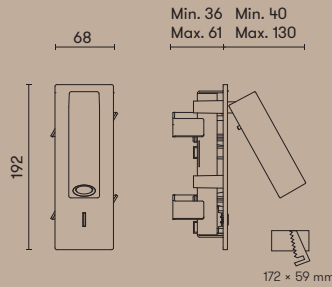

05-4787-BW-BW   
 05-4787-81-81

LED CREE 3W A++ C  
 162 lm 3000K

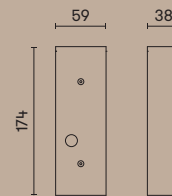

71-4787-AV-AV

Recessing kit for brick wall  
 Kit para empotrar en pared de obra  
 Kit pour encastrer au mur



Finishing | Acabados | Finitions

- BW** Matt white | Blanco mate | Blanc mate
- 81** Satin nickel | Níquel satinado | Nickel satiné

Materials | Materiales | Matériaux

- AL** Aluminium | Aluminio | Aluminium
- ZAMAK** Zamak | Zamak | Zamak

## Collection

Illuminates your spaces alongside the other pieces that comprise this collection.

## Colección

Ilumina tus espacios con el resto de piezas que componen esta colección.

## Collection

Éclairiez vos espaces avec le reste des pièces de cette collection.



Table  
 Sobremesa  
 Table p. 252



Floor  
 Pie  
 Pied p. 276



Nahtrang Disseny

---

# Talk



# Talk

**Vibrancy.** Highly singular geometric pieces made from 100% recyclable aluminium that enable the whole piece to act as a large heat dissipater, noticeably lengthening LED life.

**Dinamismo.** Piezas geométricas muy singulares realizadas con aluminio 100% reciclable que permite que toda la pieza en sí actúe como un gran disipador del calor alargando notablemente la vida del led.



**Dynamisme.** Pièces géométriques très singulières conçues en aluminium 100 % recyclable qui permettent à l'ensemble de la pièce elle-même d'agir comme un grand dissipateur de chaleur prolongeant de manière significative la durée de vie de la LED.

## Finishing | Acabados | Finitions

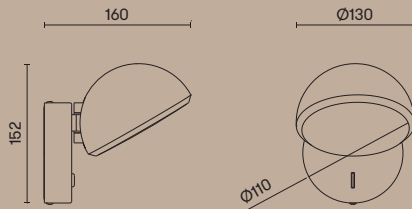

216





05-5458-BW-F9   
05-5458-Z5-F9 

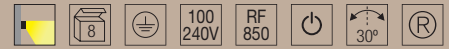

LED CREE 6.5W A++ A  
695 lm 2700K



## Finishing | Acabados | Finitions

 **BW** Matt white | Blanco mate | Blanc mate  
 **Z5** Anthracite grey | Gris antracita | Gris anthracite

## Materials | Materiales | Matériaux

 **AL** Aluminium | Aluminio | Aluminium  
 **GLASS** Diffuser material glass | Material difusor  
 **DIF** Cristal | Matériau diffusant Verre

## Collection

Illuminates your spaces alongside the other pieces that comprise this collection.

## Colección

Ilumina tus espacios con el resto de piezas que componen esta colección.

## Collection

Éclairer vos espaces avec le reste des pièces de cette collection.



Pendant  
Suspensión  
Suspension p. 160



Table  
Sobremesa  
Table p. 262



217

Francesc Vilaró

---

# Emy





# Emy

**Elegance.** This is an extensive and versatile range for contract environments where the strength of the materials and its ability to create specific atmospheres are essential. It is also ideal for installation in classic but modern spaces.

**Elegancia.** Se trata de una colección amplia y versátil orientada para entornos contract por la resistencia de sus materiales y por su capacidad de generar ambientes específicos. También está ideada para instalar en espacios clásicos pero modernos.

**Élégance.** C'est une collection vaste et polyvalente destinée aux milieux professionnels de par la résistance de ses matériaux et de sa capacité à générer des ambiances spécifiques. Elle est également conçue pour être installée dans des espaces classiques, mais modernes.

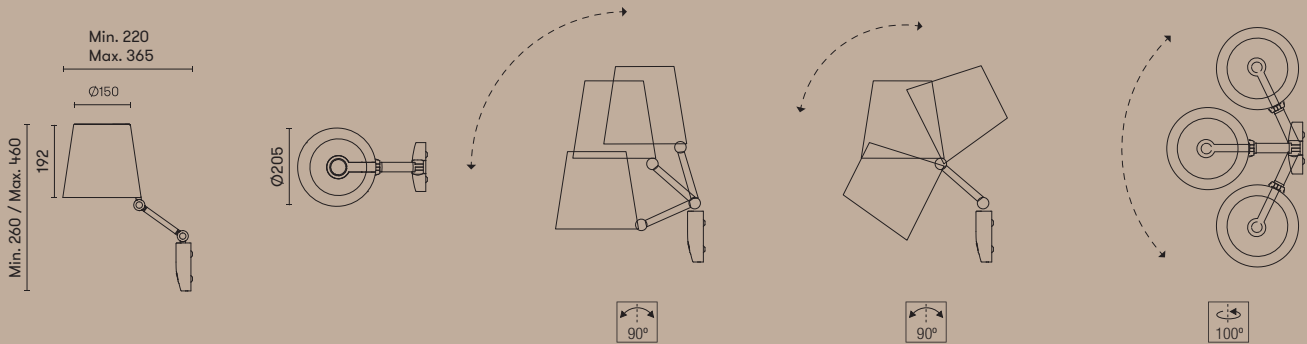

05-4409-21-12 ■

1 × E-14 Max. 15W A++ C  
Max. L=100mm Ø=45 mm  
Fluorescent - LED



## Finishing | Acabados | Finitions



21 Chrome | Cromo | Chrome



12 Smoked acrylic diffuser | Difusor acrílico fumé | Diffuseur acrylique fumé

## Materials | Materiales | Matériaux



Aluminium | Aluminio | Aluminium



Diffuser material PMMA | Material difusor PMMA | Matériau diffusant PMMA



Shade material Polycarbonate | Material pantalla Policarbonato | Matériels Abat-jour Polycarbonate

## Collection

Illuminates your spaces alongside the other pieces that comprise this collection.

## Colección

Ilumina tus espacios con el resto de piezas que componen esta colección.

## Collection

Éclairer vos espaces avec le reste des pièces de cette collection.



Pendant  
Suspensión  
Suspension p. 166



Table  
Sobremesa  
Table p. 264



Floor  
Pie  
Pied p. 296



220



Francesc Vilaró

---

# Skata

# Skata

**Versatility.** Formed of organic pieces, this sophisticated composition is a reflection of ordered chaos. The inclination of its pieces adds a sensation of volume to the compositions that work whether or not they are switched on.

**Versatilidad.** Formado por piezas de formas orgánicas, este sofisticado juego de composición se presenta como un caos ordenado. La inclinación de las piezas añade una sensación de volumen en las composiciones que funcionan tanto cuando está encendida como apagada.

**Polyvalence.** Formé par des pièces aux formes organiques, ce jeu de composition sophistiqué se présente comme un chaos ordonné. L'inclinaison des pièces ajoute une sensation de volume dans les compositions qui fonctionnent à la fois quand elle est allumée ou éteinte.

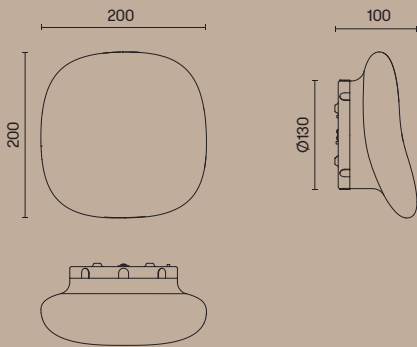

05-4750-14-F9

LED 4.3W A++ A  
413 lm 3000K



## Finishing | Acabados | Finitions

14 White | Blanco | Blanc

## Materials | Materiales | Matériaux

ST Steel | Acero | Acier

CLASS OPAL3 DIF Diffuser material triplex Opal glass | Material difusor cristal opal triplex | Matériau diffusant verre opal triplex



Its special design allows for multiple combinations.  
Su especial diseño permite múltiples combinaciones.  
Son design spécial permet de nombreuses combinaisons.

Connection scheme.  
Esquema de conexión.  
Schéma de connexion.

Benedito Design

**Igloo**

# Igloo

**Delicacy.** Available in two different sizes, this steel luminaire with a matt white finish and opal PMMA diffuser produces a sensual and delicate source of light.

**Delicadeza.** Disponible en dos medidas diferentes, esta luminaria de estructura de acero, acabados en blanco mate y difusor PMMA opal se presenta como un punto de luz sensual y delicado.

**Délicatesse.** Disponible en deux formats différents, ce luminaire doté d'une structure en acier, de finitions en blanc mat et d'un diffuseur opalin en PMMA, se présente comme un point lumineux à la fois sensuel et délicat.

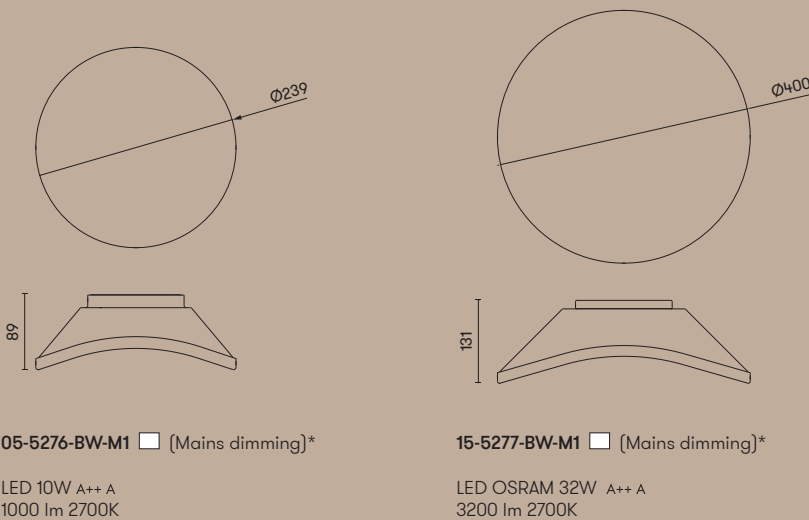

**05-5276-BW-M1**  (Mains dimming)\*

LED 10W A++ A  
1000 lm 2700K

**15-5277-BW-M1**  (Mains dimming)\*

LED OSRAM 32W A++ A  
3200 lm 2700K



## Finishing | Acabados | Finitions

**BW** Matt white | Blanco mate | Blanc mate

## Materials | Materiales | Matériaux

**ST** Steel | Acero | Acier

**PMMA** Diffuser material PMMA | Material difusor PMMA | Matériau diffusant PMMA

\* Mains dimmer compatibility at [www.leds.c4.com](http://www.leds.c4.com) (Products & Downloads)

\* Compatibilidad con reguladores corte de fase en [www.leds-c4.com](http://www.leds-c4.com) (Productos & Descargas)

\* Compatible avec des variateurs en coupure de phase que vous pouvez consulter [www.leds-c4.com](http://www.leds-c4.com) (Produits & Téléchargements)

## Collection

Illuminates your spaces alongside the other pieces that comprise this collection.

## Colección

Ilumina tus espacios con el resto de piezas que componen esta colección.

## Collection

Éclairer vos espaces avec le reste des pièces de cette collection.



Ceiling  
Techo  
Plafond p. 313



224

Benedito Design

---

# Suite

# Suite



**Reinterpretation.** A modern lamp that takes us back to classic forms with a minimalistic elliptical profile. An innovative solution has been applied to the joints to provide versatility of movement and keep all the constructive elements as low as possible.

**Reinterpretación.** Una lámpara actual que nos remite a las formas clásicas con un perfil elíptico de mínimas dimensiones. Para la versatilidad de sus movimientos, se ha aplicado una novedosa solución en las rótulas integrando todos los elementos constructivos con la menor altura posible.

**Réinterprétation.** Une lampe actuelle qui rappelle les formes classiques avec un profil elliptique aux dimensions minimales. Pour assurer la polyvalence de ses mouvements, une nouvelle solution a été appliquée dans les rotules intégrant tous les éléments de construction à la hauteur la plus basse possible.

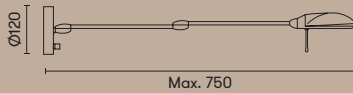
## Finishing | Acabados | Finitions



05-0380-81-B8   
05-0380-BW-B8 

1 x G9 Max. 75W A++ C  
OSRAM included

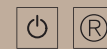

225

## Finishing | Acabados | Finitions

 81 Satin nickel | Níquel satinado | Nickel satiné

 BW Matt white | Blanco mate | Blanc mate

## Materials | Materiales | Matériaux

 ST Steel | Acero | Acier

 GLASS MAT DIF Diffuser material matt glass | Material difusor vidrio mate | Matériau diffusant Verre

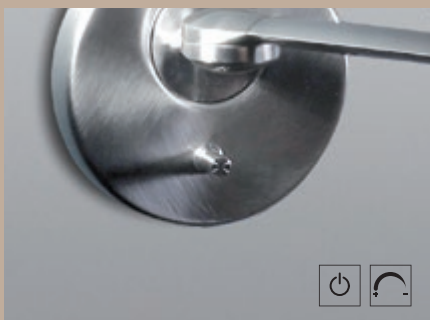



Josep Patsí

**Wave**



# Wave

**Multi-purpose.** Due to the quantity and quality of the light it generates, this is a highly versatile indoor wall lamp. It is perfect for spaces that need a lot of light, while also offering visual comfort. The carefully studied position of its LED, which points towards the wall, fully harnesses the flow of the light and avoids glare.

**Polivalencia.** Por la cantidad y calidad de la luz que genera es un aplique de interior muy polivalente. Perfecto para espacios que necesiten mucha luz pero que ofrezcan al mismo tiempo confort visual. La estudiada posición de su led, enfocado hacia la pared, aprovecha todo el flujo lumínico y evita deslumbramientos.

**Polyvalence.** La quantité et la qualité de la lumière générée en font une applique d'intérieur très polyvalente. Parfaite pour les espaces qui ont besoin de beaucoup de lumière, mais qui offre en même temps un confort visuel. La position étudiée de sa LED, axée vers le mur, profite maximise tous les flux de lumière et empêche les éblouissements.

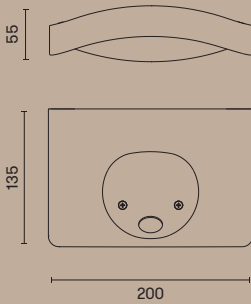

05-5488-BW-BW  (Mains dimming)\* 2700K  
05-5499-BW-BW  (Mains dimming)\* 3000K

LED CREE 17.6W A++ A  
2113 lm



## Finishing | Acabados | Finitions

BW Matt white | Blanco mate | Blanc mate

## Materials | Materiales | Matériaux

AL Aluminium | Aluminio | Aluminium

PMMA Diffuser material PMMA | Material difusor  
 DIF PMMA | Matériau diffusant PMMA

\*Mains dimmer compatibility at [www.leds-c4.com](http://www.leds-c4.com)  
(Products & Downloads)

\*Compatibilidad con reguladores corte de fase en  
[www.leds-c4.com](http://www.leds-c4.com) (Productos & Descargas)

\*Compatible avec des variateurs en coupure de phase  
que vous pouvez consulter [www.leds-c4.com](http://www.leds-c4.com)  
(Produits & Téléchargements)



Jordi Patsí

---

# Flat

# Flat



**Minimalist.** This wall light is ideal for any space, thanks to its minimalist, simple lines and top-quality materials such as metal and optical glass. Its indirect and diffused light and minimal projection from the wall make this piece easy on the eye.

**Minimalista.** Este aplique de pared es ideal para instalar en cualquier espacio gracias a sus líneas básicas minimalistas y a la nobleza de sus materiales, como el metal y el vidrio óptico. Su luz indirecta y difusa y la mínima salida desde la pared, dotan a esta luminaria de confort visual.

**Minimaliste.** Cette applique murale est idéale installée dans n'importe quel espace grâce à sa ligne minimaliste et à la noblesse de ses matériaux, tels que le métal et le verre optique. Sa lumière indirecte et diffuse, alliée à sa discrétion sur le mur, dotent cette applique de confort visuel.

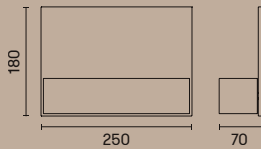
## Finishing | Acabados | Finitions



05-5093-81-B9   
05-5093-BW-B9 

LED CREE 8W A++ A  
648 lm 3000K



229

## Finishing | Acabados | Finitions

 **81** Satin nickel | Níquel satinado | Nickel satiné

 **BW** Matt white | Blanco mate | Blanc mate

## Materials | Materiales | Matériaux

 **ST** Steel | Acero | Acier

 **DIF** Diffuser material optic glass | Material difusor cristal óptico | Matériau diffusant verre optique

Table  
Sobremesa  
Table

Cocktail	232
ilargi	240
Invisible	244
Premium	248
Hall	252
Flavia	258
Talk	262
Emy	264



















# Cocktail

**Intriguing.** The original design of this portable light makes it ideal to create a special atmosphere in restaurants, hotels, terraces and homes. Available in black or white, its adjustable head can be used to aim the light to accentuate an object or area. Its 4 adjustment levels help to create the perfect ambience.

**Sugerente.** El diseño original de esta luminaria portátil la hacen ideal para vivir momentos especiales en restaurantes, hoteles, terrazas y residencias. Disponible en blanco o negro, su cabeza ajustable permite dirigir la luz, acentuando un objeto o el espacio, y sus 4 pasos de regulación ayudan a crear la atmósfera perfecta.

**Tout en suggestion.** Le design original de ce luminaire portable le rend idéal pour vivre des moments spéciaux dans les hôtels-restaurants, les résidences et en terrasse. Disponible en blanc ou noir, sa tête réglable permet de diriger la lumière, en mettant en valeur un objet ou l'espace, tandis que ses 4 phases de réglage aident à créer l'ambiance parfaite.

## Finishing | Acabados | Finitions



## Finishing | Acabados | Finitions

- 14 White | Blanco | Blanc
- 05 Black | Negro | Noir

## Materials | Materiales | Matériaux

- AL Aluminium | Aluminio | Aluminium
- PC Diffuser material polycarbonate |
- DIF Material difusor policarbonato |
- Materialu diffusant polycarbonate

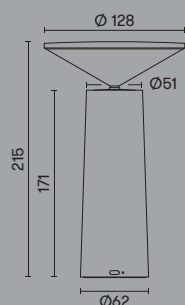

10-7063-14-14  (Touch dimming) 5VDC  
 10-7063-05-05  (Touch dimming) 5VDC

LED 3W  
 290 lm 3000K

## Technical information | Información técnica | Informations techniques



Touch dimming  
 100% - 75% - 50% - 25% - Off



Battery - Batería - Batterie  
 100% - 10h | 75% - 12h | 50% - 18h | 25% - 30h



Rotation movement 360°  
 Movimiento rotación 360°  
 Mouvement de rotation 360°

240



Iratzoki Lizaso

---

**ilargi**







# ilargi

**Naturalness.** Produced using a traditional Polish glassblowing technique, the glass ball comes in two sizes: 23 cm and 39 cm. The detailed selection of finishes and the dimmer touch on the upper part of the light create a natural ambience.

**Naturalidad.** La bola de vidrio disponible en dos tamaños, 23 cm y 39 cm, ha sido soplada a mano de manera tradicional en Polonia. La selección minuciosa de sus acabados y su atenuador táctil en la parte superior ofrece una cierta sensación de naturalidad.

**Tout en naturel.** Disponible en deux dimensions, 23 cm et 39 cm, la boule de ce modèle a été fabriquée en Pologne selon la technique traditionnelle du verre soufflé à la main. La sélection minutieuse de ses finitions et l'atténuateur tactile situé sur la partie supérieure lui confèrent une certaine sensation de naturel.

## Finishing | Acabados | Finitions

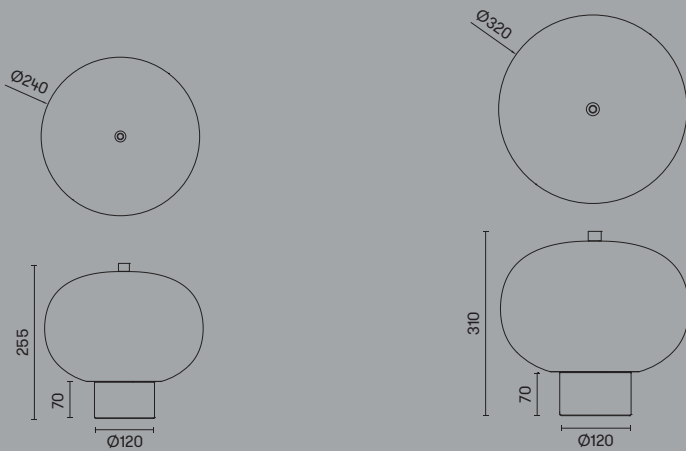

10-6010-92-F9 ■ (Touch dimming)  
10-6010-93-F9 ■ (Touch dimming)

LED 8W A++ A  
800 lm 2700K

10-6011-92-F9 ■ (Touch dimming)  
10-6011-93-F9 ■ (Touch dimming)

LED 14W A++ A  
1315 lm 2700K



## Finishing | Acabados | Finitions

■ 92 Fresno dark | Fresno oscuro  
| Frêne foncé

■ 93 Fresno light | Fresno claro |  
Frêne clair

## Materials | Materiales | Matériaux

WOOD Wood | Madera | Bois

GLASS OPAL 3  
DIF Diffuser material triplex Opal glass | Material difusor cristal opal triplex | Matériau diffusant verre opal triplex

243

## Collection

Illuminates your spaces alongside the other pieces that comprise this collection.

## Colección

Ilumina tus espacios con el resto de piezas que componen esta colección.

## Collection

Éclairez vos espaces avec le reste des pièces de cette collection.



Pendant  
Suspensión  
Suspension p. 36



244

Francesc Vilaró

---

# Invisible





# Invisible

**Authenticity.** Invisible is intuition, functionality and lightness but, above all, simplicity. And this characteristic is the source of its beauty. Its simplicity gives it an intrinsic iconic quality.

**Autenticidad.** Invisible es intuición, funcionalidad y ligereza, pero sobre todo simplicidad. Y es en esta característica donde radica su belleza. Su simplicidad la convierte en un elemento icónico por sí mismo.

**Authenticité.** Invisible est intuition, fonctionnalité et légèreté, mais surtout simplicité. Et c'est dans cette caractéristique que se trouve sa beauté. Sa simplicité en fait un élément emblématique par lui-même.

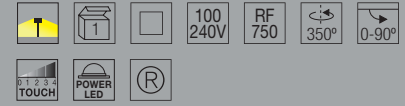
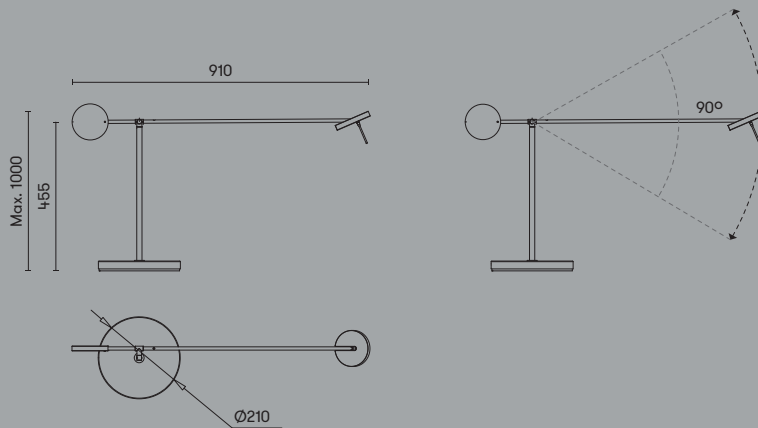

## Finishing | Acabados | Finitions

05 Black | Negro | Noir

## Materials | Materiales | Matériaux

ST Steel | Acero | Acier

PMMA Diffuser material PMMA | Material difusor PMMA | Matériau diffusant PMMA

10-5693-05-05 ■ (Touch dimming)

LED 9W  
765lm 3000K

## Collection

Illuminates your spaces alongside the other pieces that comprise this collection.

## Colección

Ilumina tus espacios con el resto de piezas que componen esta colección.

## Collection

Éclairer vos espaces avec le reste des pièces de cette collection.



Pendant  
Suspensión  
Suspension p. 94



Wall  
Pared  
Mural p. 180

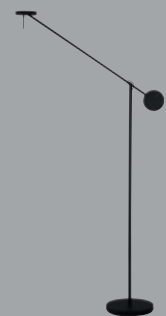

Floor  
Pie  
Pied p. 268

248



Jordi Llopis

---

# Premium







# Premium



**Warmth.** This table lamp has a classic but contemporary design, a stand with a copper or gold finish and a black screen. Switched on or off, its appearance makes it an ideal type of light for bedrooms and communal areas in hotels.

**Calidez.** Pieza de sobremesa de diseño clásico y contemporáneo con pie de acabados en cobre u oro y pantalla negra. Su presencia, tanto apagada como encendida, la sitúa como una iluminaria ideal para habitaciones y zonas comunes de hoteles.

**Chaleur.** Lampe à poser au design classique et contemporain associant un pied aux finitions cuivre ou or et un abat-jour noir. Éteint comme allumé, ce modèle à forte présence est idéal pour les chambres et les espaces publics des hôtels.

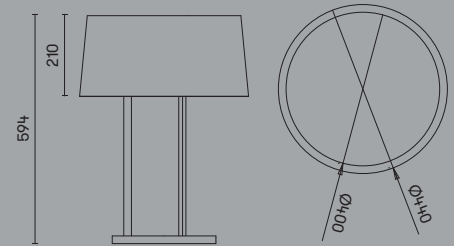
## Finishing | Acabados | Finitions



10-5076-06-H13W   
10-5076-01-H13W 

3 × E-27 Max. 18W A++ C  
Max. L=140mm Ø=52mm  
Fluorescent - LED



Top diffuser | Difusor Superior | Diffuseur Supérieur



251

## Finishing | Acabados | Finitions

 06 Cooper |  H13W Black |  
Cobre | Cuivre + SHADE Negro | Noir

 01 Gold plating |  H13W Black |  
Oro electrolítico | Dorure à l'or par + SHADE Negro | Noir  
électrolyse

## Materials | Materiales | Matériaux

 ST Steel | Acero | Acier

 TEXTIL Shade material fabric | Material pantalla tela  
SHADE | Matériels abat-jour tissu

 PMMA Diffuser material PMMA | Material difusor  
DIF PMMA | Matériau diffusant PMMA

## Collection

Illuminates your spaces alongside the other pieces that comprise this collection.

## Colección

Ilumina tus espacios con el resto de piezas que componen esta colección.

## Collection

Éclairiez vos espaces avec le reste des pièces de cette collection.



Floor  
Pie  
Pied p. 272

252



Nahtrang Disseny

---

# Hall









# Hall

**Simplicity.** The main attraction of this collection is the identity conveyed by its contemporary lines without losing the simplicity and neutrality that allows it to coexist in spaces with different styles.

**Simplicidad.** El principal atractivo de esta colección es la identidad que transmite su línea contemporánea sin perder la simplicidad y la neutralidad que le permite convivir en espacios de diferentes estilos.

**Simplicité.** Le principal atout de cette collection est l'identité que transmet sa ligne contemporaine sans perdre la simplicité et la neutralité qui lui permettent de s'intégrer dans des espaces de styles différents.

## Finishing | Acabados | Finitions

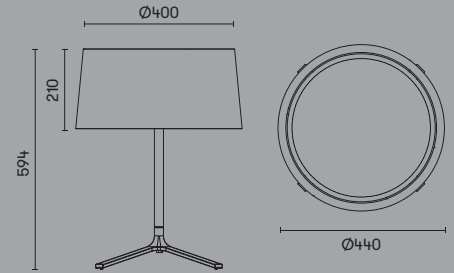

10-1940-05-H13W ■  
10-1940-BW-T007 ■

3 × E-27 Max. 18W A++ C  
Max. L=146mm Ø=52mm  
Fluorescent - LED



Top diffuser | Difusor Superior | Diffuseur Supérieur



257

## Finishing | Acabados | Finitions

■ BW Matt white | Blanco mate | Blanc mate + ■ T007 White | Blanco | Blanc

■ 05 Black | Negro | Noir + ■ H13W Black | Negro | Noir

## Materials | Materiales | Matériaux

ST Steel | Acero | Acier

TEXTIL Shade material fabric | Material pantalla tela | Matériels abat-jour tissu

PMMA Diffuser material PMMA | Material difusor PMMA | Matériau diffusant PMMA

## Collection

Illuminates your spaces alongside the other pieces that comprise this collection.

## Colección

Ilumina tus espacios con el resto de piezas que componen esta colección.

## Collection

Éclairiez vos espaces avec le reste des pièces de cette collection.



Wall  
Pared  
Mural p. 210



Floor  
Pie  
Pied p. 276



258

Benedito Design

---

# Flavia









# Flavia

**Distinction.** This collection was designed to stand out in the luminaire market for hotels and residential blocks. Its dynamic and singular solution is expressed through the inclination of the rotating arm and the moulded lampshade.

**Distinción.** El diseño de esta colección responde a la necesidad de destacar en el mercado de las luminarias para hoteles y complejos residenciales. Su solución dinámica y singular se expresa en la inclinación del brazo giratorio y en la pantalla moldeada.

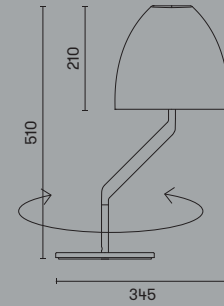
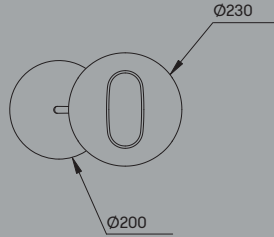
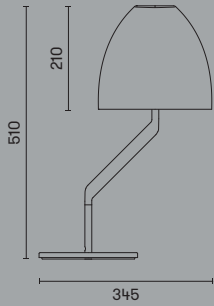
**Distinction.** Le design de cette collection répond à la nécessité de se démarquer sur le marché des luminaires pour les hôtels et complexes résidentiels. Sa solution unique et dynamique s'exprime dans l'inclinaison du bras pivotant et par l'écran moulé.



10-3686-21-M1 

1 x E-27 Max. 18W A++ C  
Max. L=125mm Ø=78mm  
Fluorescent - LED



## Finishing | Acabados | Finitions



21 Chrome | Cromo | Chrome

## Materials | Materiales | Matériaux



Zamak | Zamak | Zamak



Shade material PMMA | Material pantalla  
PMMA | Matériels abat-jour PMMA

## Collection

Illuminates your spaces alongside the other pieces that comprise this collection.

## Colección

Ilumina tus espacios con el resto de piezas que componen esta colección.

## Collection

Éclairiez vos espaces avec le reste des pièces de cette collection.



Wall  
Pared  
Mural p. 206



Floor  
Pie  
Pied p. 286



Nahtrang Disseny

---

# Talk

# Talk

**Vibrancy.** Its pieces offer multiple installation options. A single set from this collection enables us to create a highly singular luminaire that can be easily contextualised within intimate and simple spaces. However, when a number are combined, they can grow limitlessly within a space.

**Dinamismo.** Sus piezas ofrecen múltiples posibilidades de instalación. Un solo juego de esta colección nos permite tener una luminaria muy singular y fácil de contextualizar en espacios íntimos y sencillos. Pero si se combinan entre ellas, pueden crecer ilimitadamente dentro de un espacio.

**Dynamisme.** Ses pièces offrent de multiples possibilités d'installation. Un jeu unique de cette collection vous permet d'obtenir un luminaire unique et facile à contextualiser dans des espaces intimes et simples. Mais si elles sont associées entre elles, elles peuvent se développer sans limites dans un espace.

## Finishing | Acabados | Finitions

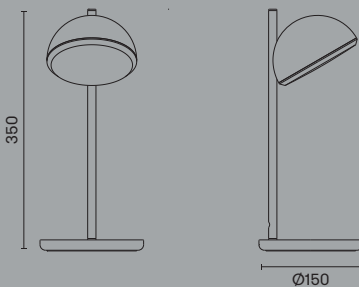

10-5458-Z5-F9 ■  
10-5458-BW-F9 ■

LED SAMSUNG 4,5W A++ A  
290 lm 2700K



## Finishing | Acabados | Finitions

**Z5** Anthracite grey | Gris antracita | Gris anthracite

**BW** Matt white | Blanco mate | Blanc mate

## Materials | Materiales | Matériaux

**AL** Aluminium | Aluminio | Aluminium

**GLASS** Diffuser material glass | Material difusor cristal | Matériau diffusant verre

263

## Collection

Illuminates your spaces alongside the other pieces that comprise this collection.

## Colección

Ilumina tus espacios con el resto de piezas que componen esta colección.

## Collection

Éclairiez vos espaces avec le reste des pièces de cette collection.



Pendant  
Suspensión  
Suspension p. 160

Wall  
Pared  
Mural p. 214



Francesc Vilaró

---

# Emy

# Emy

**Elegance.** This table lamp offers mobility that gives it a certain versatility. Its minimalist design and the strength of its materials enable specific atmospheres to be created.

**Elegancia.** Esta luminaria de sobremesa ofrece una movilidad que la dota de cierta versatilidad. Su diseño de tendencia minimalista y la resistencia de sus materiales permite generar ambientes específicos.

**Élégance.** Ce luminaire de table fournit une mobilité qui lui donne une certaine polyvalence. Son design minimaliste et la résistance de ses matériaux permettent de créer des ambiances spécifiques.

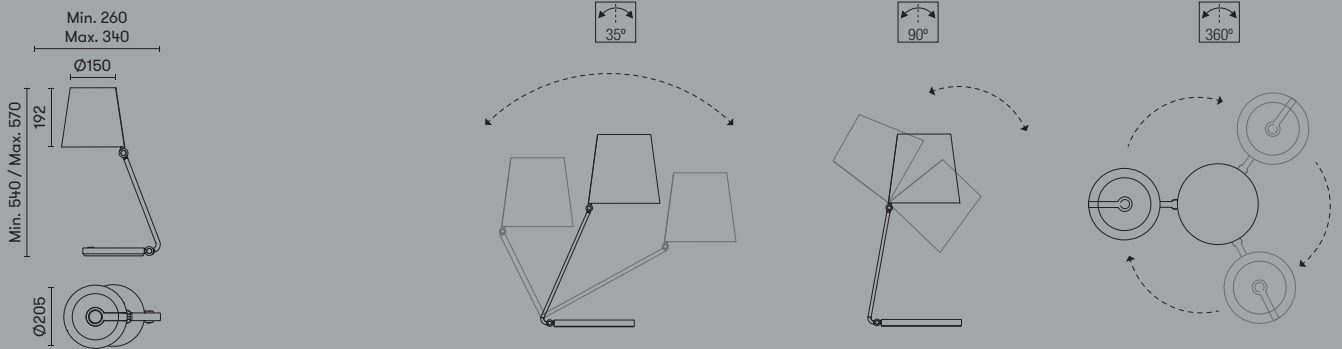

10-4409-21-12

1 x E-14 Max. 15W A++ c  
Max. L=100mm Ø=45mm  
Fluorescent - LED



## Finishing | Acabados | Finitions



12 Smoked acrylic shade | Pantalla acrílico fumé | Abat-jour acrylique fumé



21 Chrome | Cromo | Chrome

## Materials | Materiales | Matériaux



Aluminium | Aluminio | Aluminium



Diffuser material PMMA | Material difusor PMMA | Matériau diffusant PMMA



Shade material polycarbonate | Material pantalla polycarbonato | Matériels abat-jour polycarbonate

## Collection

Illuminates your spaces alongside the other pieces that comprise this collection.

## Colección

Ilumina tus espacios con el resto de piezas que componen esta colección.

## Collection

Éclairer vos espaces avec le reste des pièces de cette collection.



Pendant  
Suspensión  
Suspension p. 166



Wall  
Pared  
Mural p. 217



Floor  
Pie  
Pied p. 296





	Invisible	268
	Premium	272
	Hall	276
	Circ	282
	Flavia	286
<u>Floor</u>	Bosquet	290
<u>Pie</u>	Bamboo	293
	Emy	296
<u>Pied</u>	Medusa	299



Francesc Vilaró

---

# Invisible





# Invisible

**Authenticity.** Its minimalist design is also reflected in its component parts: which are stripped down to the basics necessary to allow it to perform its function. This lamp has three essential components: an LED light source, two identical circumferences that act as counterweights for one another and a thin tube connecting them.

**Autenticidad.** Su diseño minimalista también se refleja en los elementos que la componen: los justos y necesarios para cumplir su funcionalidad. Tres son sus componentes esenciales: fuente de luz led, dos circunferencias homólogas que trabajan como contrapeso entre sí y un tubo delgado que los une.

**Authenticité.** Son design minimaliste se reflète aussi dans les éléments qui la composent : justes et nécessaires pour remplir leur fonction. Trois composants sont essentiels : source de lumière LED, deux circonférences semblables travaillant comme un contrepoids entre elles, et un mince tube qui les relie.

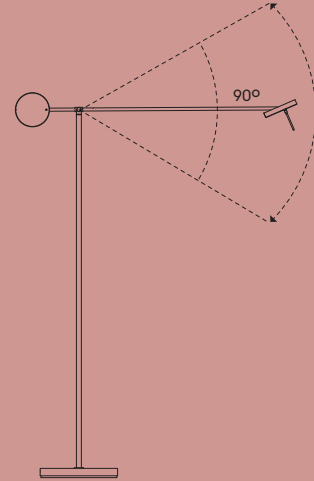
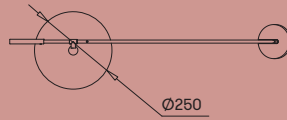
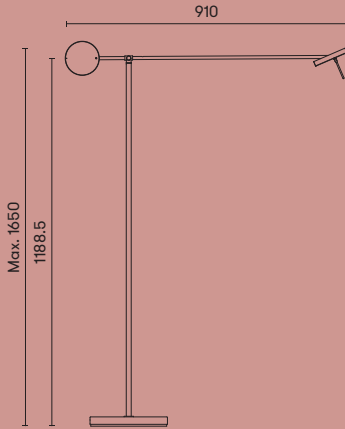

25-5693-05-05 ■

LED 9W  
765lm 3000K

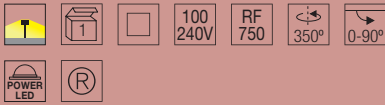

## Finishing | Acabados | Finitions

05 Black | Negro | Noir

## Materials | Materiales | Matériaux

ST Steel | Acero | Acier

PMMA Diffuser material PMMA | Material difusor  
PMMA | Matériau diffusant PMMA

271

## Collection

Illuminates your spaces alongside the other pieces that comprise this collection.

## Colección

Ilumina tus espacios con el resto de piezas que componen esta colección.

## Collection

Éclairiez vos espaces avec le reste des pièces de cette collection.



Pendant  
Suspensión  
Suspension p. 94



Wall  
Pared  
Mural p. 180



Table  
Sobremesa  
Table p. 244

272



Jordi Llopis

---

# Premium







# Premium

**Warmth.** With a copper or gold finish and black screen, this light is highly distinctive. Switched off, it is like a sculpture that gives character to a particular space and, switched on, it provides a warm and sophisticated light.

**Calidez.** Esta iluminaria de acabados cobre u oro y pantalla negra tiene mucha presencia. Apagada actúa como una escultura que ayuda a construir el espacio y, encendida proporciona una luz cálida y elegante.

**Chaleur.** Doté de finitions cuivre ou or et d'un abat-jour noir, ce luminaire possède une forte présence. Éteint, il agit comme une sculpture qui aide à modeler l'espace, tandis qu'allumé il offre une lumière chaude et élégante.

## Finishing | Acabados | Finitions

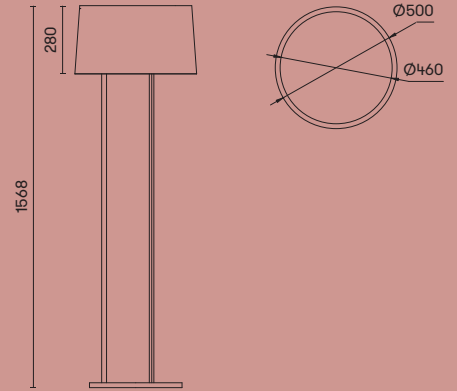
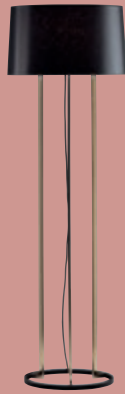
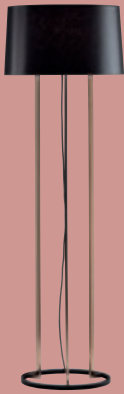

25-5076-06-H13W  
25-5076-01-H13W

3 × E-27 Max. 30W A++ C  
Max. L=176mm Ø=60mm  
Fluorescent - LED



Top diffuser | Difusor Superior | Diffuseur Supérieur



275

## Finishing | Acabados | Finitions

06 Cooper | Cobre | Cuivre + H13W Black | Negro | Noir  
SHADE

01 Gold plating | Oro electrolítico | Dorure à l'or par électrolyse + H13W Black | Negro | Noir  
SHADE

## Materials | Materiales | Matériaux

ST Steel | Acero | Acier

TEXTIL Shade material fabric | Material pantalla tela | Matériels abat-jour tissu  
SHADE

PMMA Diffuser material PMMA | Material difusor PMMA | Matériau diffusant PMMA  
DIF

## Collection

Illuminates your spaces alongside the other pieces that comprise this collection.

## Colección

Ilumina tus espacios con el resto de piezas que componen esta colección.

## Collection

Éclairiez vos espaces avec le reste des pièces de cette collection.



Table  
Sobremesa  
Table p. 248

276



Nahrang Disseny

---

# Hall









# Hall

**Simplicity.** This collection has been created to make it an essential element of the hotel sector that also enhances the design of its surroundings thanks to the definition of its lines and its more detailed shapes.

**Simplicidad.** Esta colección se ha creado para posicionarse como una pieza básica en el sector hotelero pero que ofrece un plus en el diseño gracias a la definición de sus líneas y de sus formas más detalladas.

**Simplicité.** Cette collection a été créée pour se positionner comme une pièce basique dans le secteur hôtelier, mais offre un plus dans son design grâce à la définition de ses lignes et de ses formes plus détaillées.

## Finishing | Acabados | Finitions

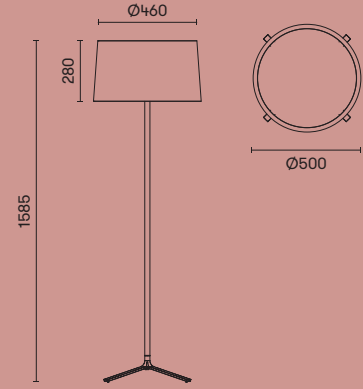
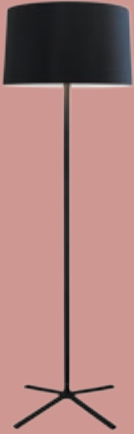

25-1940-05-H13W ■  
25-1940-BW-T007 □

3 x E-27 Max. 30W A++ c  
Max. L=176mm Ø=60mm  
Fluorescent - LED



Top diffuser | Difusor Superior | Diffuseur Supérieur



281

## Finishing | Acabados | Finitions

■ 05 Black | Negro | Noir + ■ H13W Black | Negro | Noir  
SHADE

□ BW Matt white | Blanco mate | Blanc mate + □ T007 White | Blanco | Blanc  
SHADE

## Materials | Materiales | Matériaux

ST Steel | Acero | Acier

TEXTIL Shade material fabric | Material pantalla tela |  
SHADE Matériels abat-jour tissu

PMMA Diffuser material PMMA | Material difusor  
DIF PMMA | Matériau diffusant PMMA

## Collection

Illuminates your spaces alongside the other pieces that comprise this collection.

## Colección

Ilumina tus espacios con el resto de piezas que componen esta colección.

## Collection

Éclairiez vos espaces avec le reste de pièces de cette collection.



Wall  
Pared  
Mural p. 210



Table  
Sobremesa  
Table p. 252



Josep Patsí

---

**Circ**







# Circ

**Lightness.** This luminaire offers minimalist expression with minimal volume, but it is capable of filling any space due to its highly effective light diffusion. It gives a sensation of lightness and it appears as though the piece is emitting its own light.

**Ligereza.** Es la mínima expresión con un mínimo volumen, pero con la capacidad de llenar cualquier espacio por la difusión de su iluminación. Aporta una sensación de ligereza y de que la pieza tiene una iluminación propia.

**Légèreté.** Réduit à sa plus simple expression dans un minimum de volume, ce modèle sait néanmoins remplir n'importe quel espace par la diffusion de sa lumière. Il apporte une sensation de légèreté et de lumière qui émane de nulle part.



25-2934-BW-M3

LED 27W A++ A  
2.592 lm 3000K

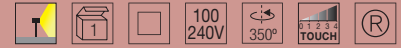

**Finishing | Acabados | Finitions**

**BW** Matt white | Blanco mate | Blanc mate

**Materials | Materiales | Matériaux**

**AL** Aluminium | Aluminio | Aluminium

**PMMA** Diffuser material PMMA | Material difusor PMMA |  **DIF** PMMA | Matériau diffusant PMMA

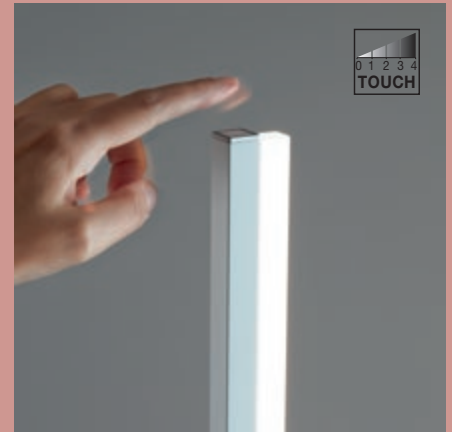
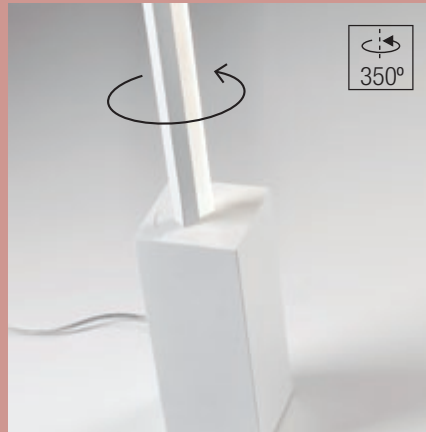
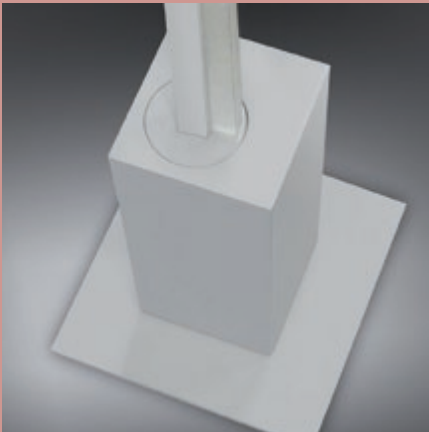

285

71-2934-BW-BW

Accessory for transit areas  
Accesorio para zonas transitadas  
Accessoire pour zones de passage

## Collection

Illuminates your spaces alongside the other pieces that comprise this collection.

## Colección

Ilumina tus espacios con el resto de piezas que componen esta colección.

## Collection

Éclairiez vos espaces avec le reste de pièces de cette collection.



Pendant  
Suspensión  
Suspension p. 114



Ceiling  
Techo  
Plafond p. 304



Benedito Design

---

# Flavia







# Flavia

**Distinction.** With minimal impact, this piece adds character and provides expressiveness wherever it is installed. Furthermore, great efforts have been made to ensure design consistency between all the pieces to help unify the range.

**Distinción.** Se trata de una pieza que imprime carácter y que aporta expresividad, mediante una mínima intervención, en los espacios donde se coloca. Además, se ha cuidado la coherencia en el diseño de todas las piezas que ayuda a unificar toda la gama.

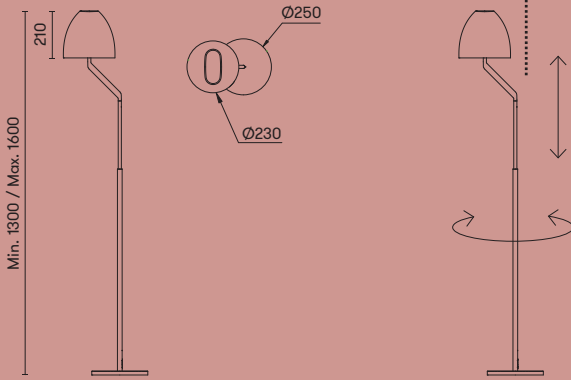
**Distinction.** Il s'agit d'une pièce qui donne du caractère et apporte de l'expressivité grâce à une intervention minimale dans les espaces où elle est placée. En outre, la cohérence a été soignée dans la conception de toutes les pièces aidant ainsi à unifier toute la gamme.



25-3686-21-M1 

1 x E-27 Max. 18W A++ C  
Max. L=125mm Ø=78mm  
Fluorescent - LED



**Finishing | Acabados | Finitions**

 21 Chrome | Cromo | Chrome

**Materials | Materiales | Matériaux**

 Zamak | Zamak | Zamak

 Shade material PMMA | Material pantalla PMMA | Matériels abat-jour PMMA

## Collection

Illuminates your spaces alongside the other pieces that comprise this collection.

## Colección

Ilumina tus espacios con el resto de piezas que componen esta colección.

## Collection

Éclairer vos espaces avec le reste des pièces de cette collection.



Wall  
Pared  
Mural p. 206



Table  
Sobremesa  
Table p. 258



Ramón Valls

---

# Bosquet





# Bosquet

**Contrast.** Like a sculpture, this aluminium piece with organic forms creates light, shadow and reflections in the form of a spiral reaching towards the ceiling, giving it volume.

**Contraste.** Como si se tratase de una escultura, esta pieza de aluminio y de formas orgánicas, genera luces y sombras y reflejos en forma de espiral hacia el techo que le da volumen.

**Contraste.** Telle une sculpture, cette pièce en aluminium aux formes organiques produit des jeux d'ombres et de lumière ponctués de reflets en forme de spirale ascendante qui lui donnent du volume.

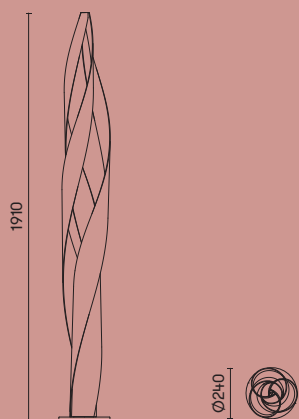

25-1837-05-05 ■

1 × E-27 Max. 150W A++ C  
 Max. L=195 mm Ø=60 mm  
 Halogen - Fluorescent - LED  
 Recommended E-27 PAR 30 Max. 75W



## Finishing | Acabados | Finitions

05 Black | Negro | Noir

## Materials | Materiales | Matériaux

AL Aluminium | Aluminio | Aluminium



293

Gemma Bernal

---

# Bamboo



# Bamboo

**Honesty.** Nature and traditional crafts combine in these pieces. The lighting effect created can be adapted to all requirements: abundant light, light effects or shadows and low light. The LED strips are covered by a plastic tube to provide controlled, uniform and diffuse light.

**Honestidad.** La naturaleza y la artesanía se unen en estas piezas. El efecto lumínico que genera se adapta a todas las necesidades: mucha luz, efectos de luz y sombras y poca luz. Las tiras de led recubiertas con un tubo de plástico nos dan una luz controlada, uniforme y difusa.

**Honnêteté.** La nature et l'artisanat sont réunis dans ces pièces. L'effet d'éclairage qu'il génère s'adapte à tous les besoins : beaucoup de lumière, des jeux de lumière et d'ombres et peu de lumière. Les bandes de LED recouvertes d'un tube en plastique vous donnent une lumière uniforme, diffuse et contrôlée.

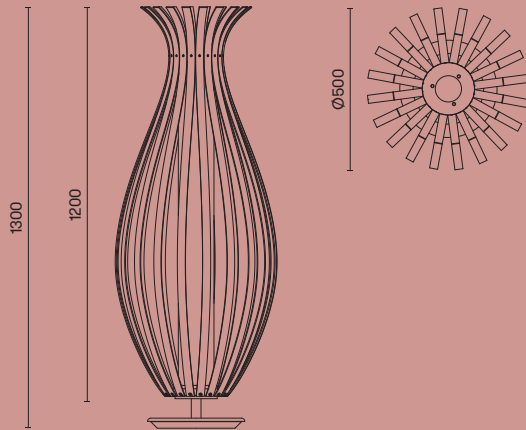

25-4035-CT-93 ■

LED 22W A++ A  
1870 lm 3000K



Bamboo | Bambú | Bambou



295

## Finishing | Acabados | Finitions

■ CT Wood brown | Marrón madera | Bois marron

## Materials | Materiales | Matériaux

ST Steel | Acero | Acier

WOOD Wood | Madera | Bois

PMMA Diffuser material PMMA | Material difusor PMMA | Matériau diffusant PMMA

## Collection

Illuminates your spaces alongside the other pieces that comprise this collection.

## Colección

Ilumina tus espacios con el resto de piezas que componen esta colección.

## Collection

Éclairer vos espaces avec le reste des pièces de cette collection.



Pendant  
Suspensión  
Suspension p. 151



Francesc Vilaró

---

**Emy**



# Emy

**Elegance.** This piece's elegant and classic shapes, offer excellent functionality and highly specific treatment of the light through the carefully designed dual polycarbonate lampshade. Its composition and materials give it a certain presence and a perception of quality.

**Elegancia.** Esta pieza, de formas elegantes y clásicas, ofrece altas funcionalidades y un trato de la luz muy específico por la estudiada trama de la doble pantalla de policarbonato. Su composición y materiales la dota de cierta presencia y de una percepción de calidad.

**Élégance.** Cette pièce, aux formes élégantes et classiques, offre de grandes fonctionnalités et un traitement très spécifique de la lumière grâce à la trame étudiée du double écran en polycarbonate. Sa composition et ses matériaux lui donnent une certaine présence et une perception de qualité.

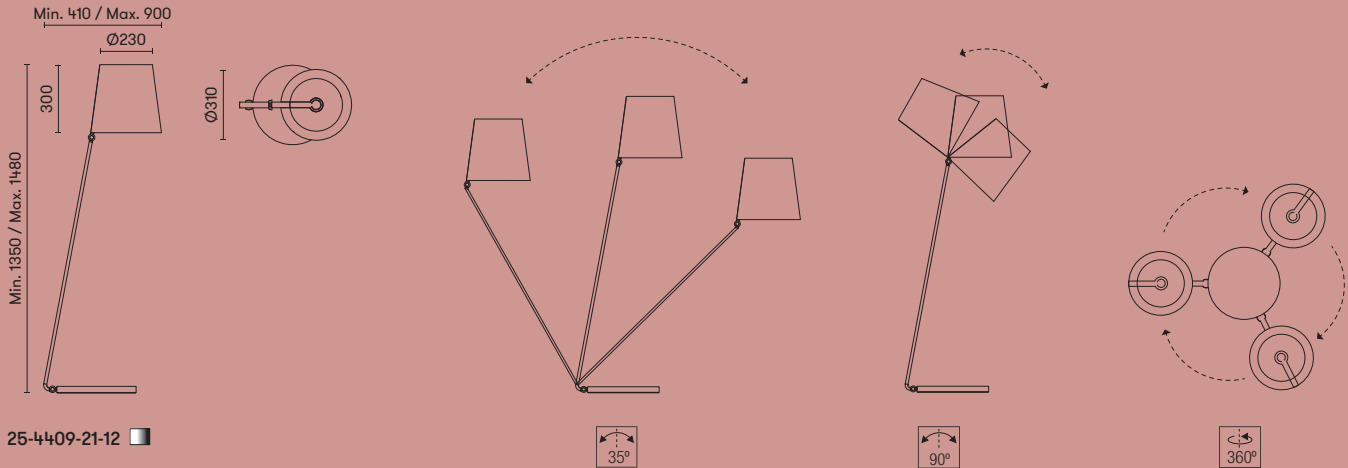

25-4409-21-12 ■

1 x E-27 Max. 30W A++ C  
Max. L=180mm Ø=60mm  
Fluorescent - LED

298

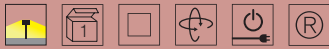

## Finishing | Acabados | Finitions

21 Chrome | Cromo | Chrome

SHADE 12 Smoked acrylic shade | Pantalla acrílico fumé | Abat-jour acrylique fumé

## Materials | Materiales | Matériaux

AL Aluminium | Aluminio | Aluminium

PC SHADE Shade material polycarbonate | Material pantalla policarbonato | Matériels abat-jour polycarbonate

PMMA DIF Diffuser material PMMA | Material difusor PMMA | Matériau diffusant PMMA

## Collection

Illuminates your spaces alongside the other pieces that comprise this collection.

## Colección

Ilumina tus espacios con el resto de piezas que componen esta colección.

## Collection

Éclairer vos espaces avec le reste des pièces de cette collection.



Pendant  
Suspensión  
Suspension p. 166



Wall  
Pared  
Mural p. 217



Table  
Sobremesa  
Table p. 264





299

Ramón Valls

---

# Medusa

300



# Medusa



**Marina.** Its organic design provides good light diffusion. The lampshade of this jellyfish-shaped floor lamp comes in two different finishes and materials: grey textile or white PVC.

**Marina.** El diseño orgánico de sus formas permite una buena difusión de la luz. La pantalla de esta luminaria en forma de medusa, ofrece dos acabados y materiales a escoger: textil gris y PVC blanco.

**Air marin.** La ligne organique de ses formes permet une bonne diffusion de la lumière. L'abat-jour de ce luminaire en forme de méduse offre le choix entre deux finitions et matériaux : textile gris et PVC blanc.

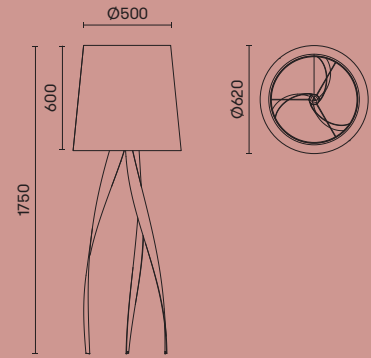
## Finishing | Acabados | Finitions







25-1824-BW-T002   
25-1824-BW-T003 

1 x E-27 Max. 30W A++ C  
Max. L=195mm Ø=60mm  
Fluorescent - LED



## Finishing | Acabados | Finitions

 BW Matt white |  
Blanco mate | +  **TEXTIL** T002 Grey |  
**SHADE** Gris | Gris  
Blanc mate

 BW Matt white |  
Blanco mate | +  **PVC** T003 White |  
**SHADE** Blanco | Blanc  
Blanc mate

## Materials | Materiales | Matériaux

 AL Aluminium | Aluminio | Aluminium

 **TEXTIL** Shade material fabric | Material pantalla tela |  
**SHADE** Matériels abat-jour tissu

 **PVC** Shade material PVC | Material pantalla PVC |  
**SHADE** Matériels abat-jour PVC





Ceiling  
Techo  
Plafond

Circ	304
Spin	308
Six	310
Igloo	313
Tandem	316
Single	318

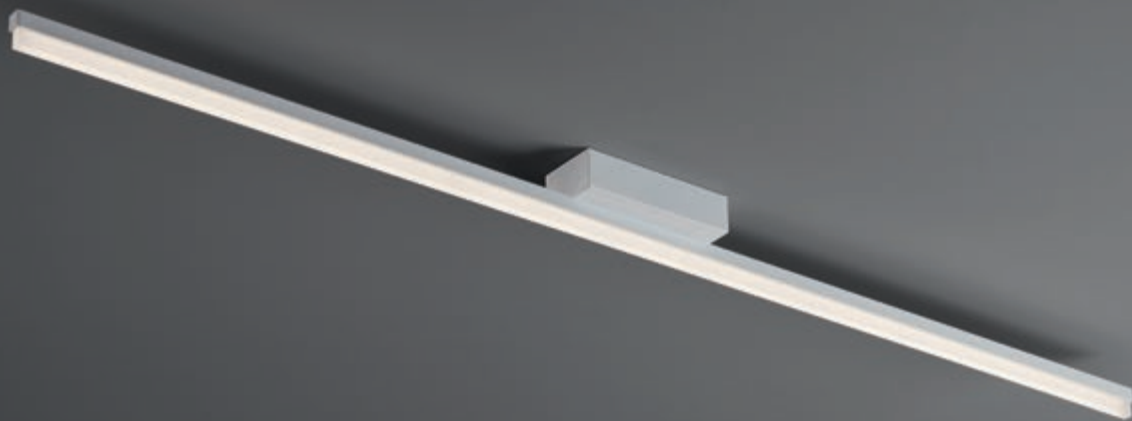







# Circ

**Lightness.** This piece is suitable for both domestic spaces and large-scale spaces since various combinations of shapes and sizes can be made.

**Ligereza.** Esta pieza puede adecuarse a diferentes espacios, tanto domésticos como de grandes dimensiones, gracias a la posibilidad de realizar combinaciones de varios tamaños y formas.

**Légèreté.** Ce modèle peut s'adapter à différents espaces, qu'ils soient domestiques ou grand format, grâce à la possibilité de combiner des dimensions et formes variées.

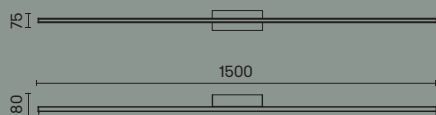

15-4875-BW-M3 

15-4871-BW-M3 (Mains dimming)\* 

LED 26W A++ A  
2496 lm 3000K



## Finishing | Acabados | Finitions



BW Matt white | Blanco mate | Blanc mate

## Materials | Materiales | Matériaux



Aluminium | Aluminio | Aluminium



Diffuser material PMMA | Material difusor



PMMA | Matériau diffusant PMMA

\* Mains dimmer compatibility at [www.leds.c4.com](http://www.leds.c4.com) (Products & Downloads)

\* Compatibilidad con reguladores corte de fase en [www.leds-c4.com](http://www.leds-c4.com) (Productos & Descargas)

\* Compatible avec des variateurs en coupure de phase que vous pouvez consulter [www.leds-c4.com](http://www.leds-c4.com) (Produits & Téléchargements)

## Collection

Illuminates your spaces alongside the other pieces that comprise this collection.

## Colección

Ilumina tus espacios con el resto de piezas que componen esta colección.

## Collection

Éclairiez vos espaces avec le reste des pièces de cette collection.

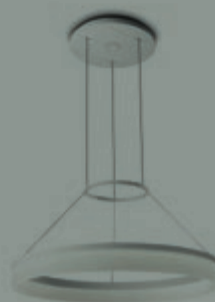

Pendant  
Suspensión  
Suspension p. 114



Floor  
Pie  
Pied p. 282

308



Nahtrang Disseny

---

**Spin**

# Spin

**Kindness.** The basic lighting concept of this luminaire allows it to fit into contract spaces and counteract their cold atmosphere, bringing warmth and kindness. In the home, it also serves as a neutral but decorative piece that illuminates and brings warmth to all environments.

**Amabilidad.** Su concepción básica de la iluminación le permite integrarse en espacios contract para contrarrestar su ambiente frío y dotarlos de amabilidad. Y también en el hogar presentándose como una pieza neutra pero decorativa que ilumina y da calidez a todos los entornos.

**Amabilité.** Sa conception basique de l'éclairage lui permet de s'intégrer dans des espaces professionnels pour contrer l'ambiance froide et leur apporter un caractère plus chaleureux. Il peut aussi convenir à un foyer en se présentant comme une pièce neutre mais décorative qui éclaire et apporte de la chaleur à tous les milieux.

## Finishing | Acabados | Finitions



## Finishing | Acabados | Finitions

- 05** Black | Negro | Noir
- BW** Matt white | Blanco mate | Blanc mate
- 21** Chrome | Cromo | Chrome

## Materials | Materiales | Matériaux

- ST Steel | Acero | Acier
- PMMA Diffuser material PMMA | Material difusor PMMA | Matériau diffusant PMMA
- TEX  
TIL Fabric | Tela | Tissu

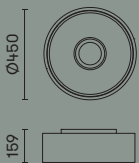

15-4601-21-05   
15-4601-21-14

3 × E-27 Max. 23W A++ C  
Max. L=190mm Ø=60mm  
Fluorescent - LED

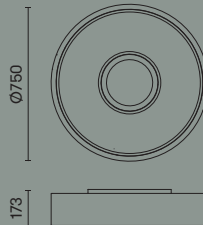

15-4607-21-05   
15-4607-21-14

5 × E-27 Max. 30W A++ C  
Max. L=190mm Ø=60mm  
Fluorescent - LED

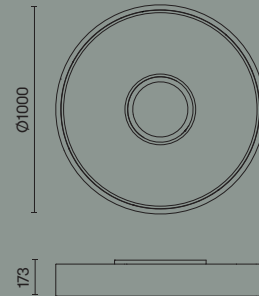

15-4615-21-05   
15-4615-21-14

7 × E-27 Max. 30W A++ C  
Max. L=190mm Ø=60mm  
Fluorescent - LED

309

## Collection

Illuminates your spaces alongside the other pieces that comprise this collection.

## Colección

Ilumina tus espacios con el resto de piezas que componen esta colección.

## Collection

Éclairiez vos espaces avec le reste des pièces de cette collection.



Pendant  
Suspensión  
Suspension p. 145



310

Josep Patsí

---

**Six**



# Six

**Spectacular.** Offers a high light output thanks to the PCB LED backlight and it is very easy to install. Its hexagonal geometric shape and the three different height options allow for the creation of spectacular compositions.

**Espectacular.** Ofrece un alto rendimiento lumínico gracias al led PCB backlight y es de muy fácil instalación. Su forma geométrica hexagonal y el juego de tres alturas diferentes permite crear composiciones espectaculares.

**Spectaculaire.** Très facile à installer, ce luminaire offre un rendement lumineux élevé grâce à sa lampe LED à rétroéclairage sur PCB. Sa forme géométrique hexagonale et le jeu de trois hauteurs différentes permet de créer des compositions spectaculaires.

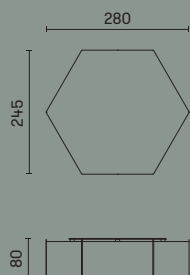

15-1950-BW-M1

LED 13W  
1440 lm 3000K

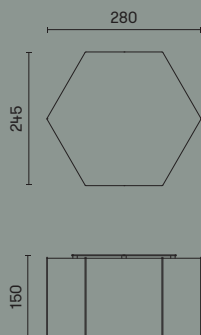

15-1956-BW-M1

LED 13 W  
1440 lm 3000K

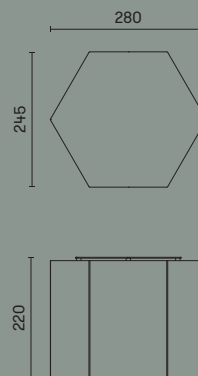

15-1959-BW-M1

LED 13W  
1440 lm 3000K

312



Its special design allows for multiple combinations.  
Su especial diseño permite múltiples combinaciones.  
Son design spécial permet de nombreuses combinaisons.

Connection scheme.  
Esquema de conexión.  
Schéma de connexion.



## Finishing | Acabados | Finitions

BW Matt white | Blanco mate | Blanc mate

## Materials | Materiales | Matériaux

AL Aluminium | Aluminio | Aluminium

PC **DIF** Diffuser material polycarbonate | Material difusor policarbonato | Matériau diffusant polycarbonate

For dimmable versions, please get in contact with your sales representative.  
Para versiones regulables, por favor consulte con equipo comercial.  
Pour les versions réglables, veuillez consulter l'équipe commerciale.



313

Benedito Design

---

# Igloo





# Igloo

**Delicacy.** This LED ceiling lamp adapts to any space thanks to its organic lines and its direct, sensual and delicate light.

**Delicadeza.** Esta luminaria led de techo se adapta a cualquier espacio gracias a sus formas orgánicas y a su luz directa, sensual y delicada.

**Délicatesse.** Ce plafonnier LED s'adapte à n'importe quel espace grâce à ses formes organiques et à sa lumière directe, sensuelle et délicate.

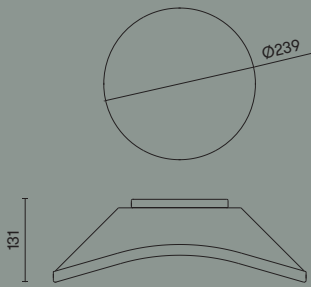

05-5276-BW-M1  (Mains dimming)\*

LED OSRAM A++ A  
1.000 lm 2700K

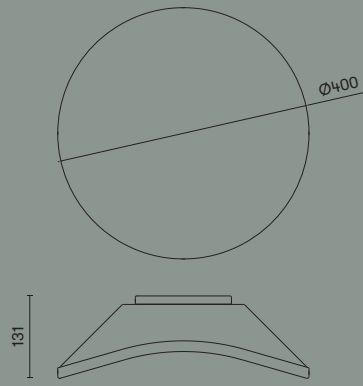

15-5277-BW-M1  (Mains dimming)\*

LED OSRAM 32W A++ A  
3.200 lm 2700K



## Finishing | Acabados | Finitions

BW Matt white | Blanco mate | Blanc mate

## Materials | Materiales | Matériaux

ST Steel | Acero | Acier

PMMA Diffuser material PMMA | Material difusor  
 DIF PMMA | Matériau diffusant PMMA

\* Mains dimmer compatibility at [www.leds.c4.com](http://www.leds.c4.com) (Products & Downloads)

\* Compatibilidad con reguladores corte de fase en [www.leds-c4.com](http://www.leds-c4.com) (Productos & Descargas)

\* Compatible avec des variateurs en coupure de phase que vous pouvez consulter [www.leds-c4.com](http://www.leds-c4.com) (Produits & Téléchargements)

## Collection

Illuminates your spaces alongside the other pieces that comprise this collection.

## Colección

Ilumina tus espacios con el resto de piezas que componen esta colección.

## Collection

Éclairer vos espaces avec le reste des pièces de cette collection.



Wall  
Pared  
Mural p. 222



316

Benedito Design

---

# Tandem

# Tandem

**Rational.** With a sombre and rational exterior, this luminaire adapts to a wide range of spaces to offer a technically impeccable interior. This luminaire is the expression of simplicity with a guarantee for the future.

**Racional.** Con un exterior sobrio y racional se adecua a una amplia gama de interiores y ofrece un interior técnicamente impecable. Esta luminaria es la expresión de la sencillez con garantía de futuro.

**Rationnel.** Doté d'une ligne extérieure sobre et rationnelle, ce modèle s'adapte à un vaste éventail de décors tout en offrant un intérieur techniquement impeccable. Ce luminaire est synonyme de simplicité et de garantie d'avenir.

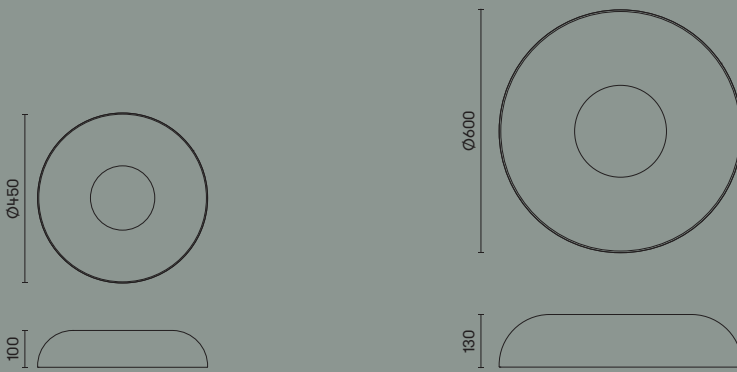

15-0778-BW-M1

1 × 2GX13 55W A++ B

15-0056-BW-M1

1 × 2GX13 40W  
+ 1 × 2GX13 22 W A++ B



## Finishing | Acabados | Finitions

BW Matt white | Blanco mate | Blanc mate

## Materials | Materiales | Matériaux

ST Steel | Acero | Acier

PMMA Diffuser material PMMA | Material difusor PMMA | Matériau diffusant PMMA

## Collection

Illuminates your spaces alongside the other pieces that comprise this collection.

## Colección

Ilumina tus espacios con el resto de piezas que componen esta colección.

## Collection

Éclairer vos espaces avec le reste des pièces de cette collection.



Pendant  
Suspensión  
Suspension p. 149



318

Josep Patsí

---

# Single

# Single

**Floating.** The indirect light emitted by this luminaire is derived from a floating sphere that directs the light towards a circular reflector, creating a very comfortable atmosphere. It uses a high-performance LED with a simple and minimalistic design.

**Flotante.** La luz indirecta de esta luminaria se genera gracias a una esfera flotante que dirige la luz hacia un reflector circular y que provoca un ambiente muy confortable. Emplea un led de alto rendimiento con un diseño sencillo y minimalista.

**Flottant.** La lumière indirecte de ce luminaire est produite par une sphère flottante qui la dirige vers un réflecteur circulaire, pour une atmosphère très confortable. Muni d'une lampe LED haut rendement de ligne simple et minimaliste.

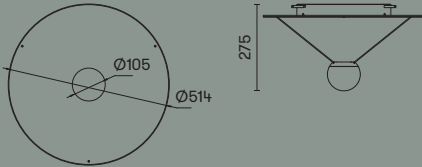

15-5099-D9-D9  

15-5100-D9-D9  (Mains dimming)\* 

LED 25W A++ A  
3011 lm 2700K



## Finishing | Acabados | Finitions

 D9 Silver leaf | Pan de plata | Feuille d'argent +  21 Chrome | Cromo | Chrome

## Materials | Materiales | Matériaux

 ST Steel | Acero | Acier

\* Mains dimmer compatibility at [www.leds.c4.com](http://www.leds.c4.com) (Products & Downloads)

\* Compatibilidad con reguladores corte de fase en [www.leds-c4.com](http://www.leds-c4.com) (Productos & Descargas)

\* Compatible avec des variateurs en coupure de phase que vous pouvez consulter [www.leds-c4.com](http://www.leds-c4.com) (Produits & Téléchargements)

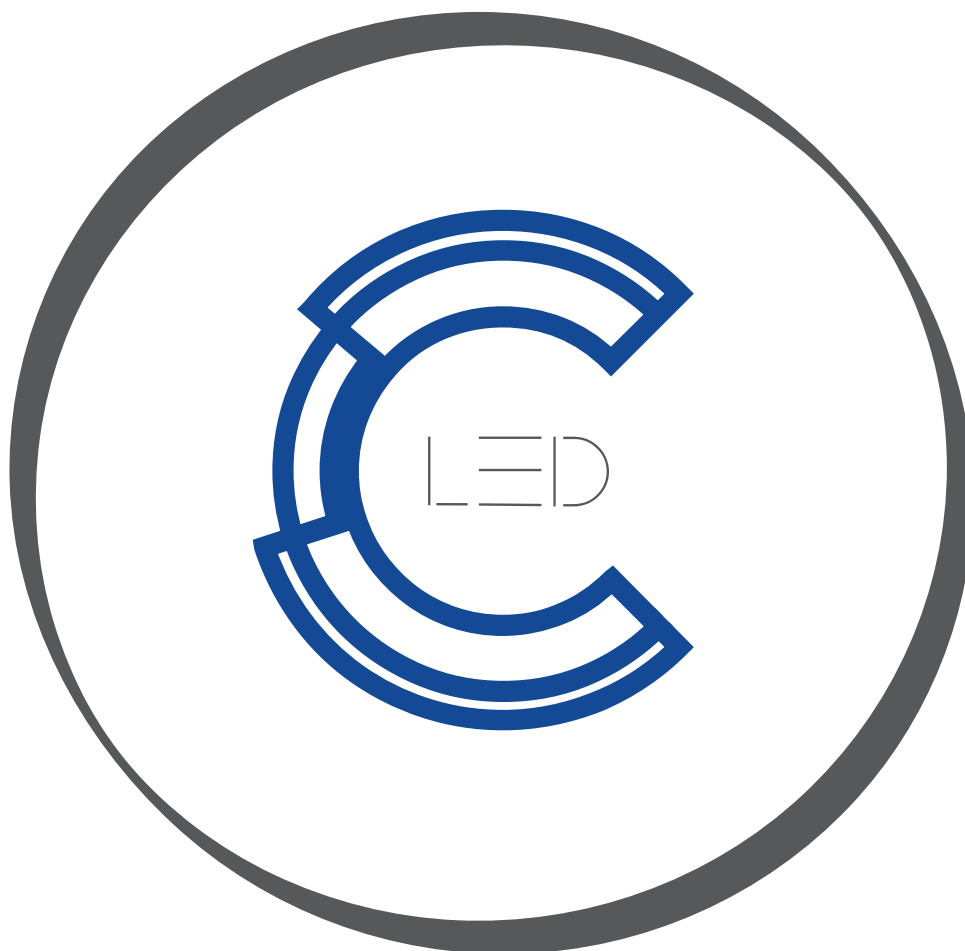

CONNECTILED  
96 Bis rue des Cicottées  
37550 Saint-Avertin

**[WWW.CONNECTILED.COM](http://WWW.CONNECTILED.COM)**

Nous suivre sur les réseaux

